

ORCA-Quest 2 qCMOS Camera C15550-22UP / C15550-22UP01 Instruction manual

Thank you for your purchase

 **CAUTION**

- Follow the safety precautions in Chapter 1 in order to avoid personal injury and damage to property when using this camera. The manual describes the correct handling method of the camera and provides instructions that should be followed to avoid accidents. **Read this manual carefully** before using this camera. After reading this manual, store it in a location where you can refer to it at any time.



Ver.1.1
May. 2024

HAMAMATSU PHOTONICS K.K.

1. SAFETY PRECAUTIONS







1-1 SYMBOLS

The symbols shown below are used for this camera.

	Direct current
	Alternating current

1-2 CLASSIFICATION OF WARNINGS

We have classified the warnings symbols that appear in this instruction manual and on the camera as follows for your convenience. Make sure that you fully understand them and follow the instructions they contain.

 WARNING	Improper handling of the camera without observing these warnings could lead to serious injury to the user and even death.
 CAUTION	Improper handling of the camera without observing these cautions could lead to personal injury to the user or damage to property.
	This symbol indicates a cautionary item that should be followed when handling the camera. Read the contents carefully to ensure correct and safe use.
	This symbol indicates an action that is forbidden. Read and follow the instructions carefully.
	This symbol indicates a compulsory action or instruction. Read and follow the instructions carefully.
 Note	This symbol indicates a note to help you get the best performance from the camera. Read the contents of the note carefully to ensure correct and safe use. Failure to observe one of these notes might impair the performance of the camera.

 **WARNING**



Power supply

Use the camera with the indicated voltage on the rating sticker. Using a different voltage can damage the camera and lead to fire or electric shock.



Cables

Do not to place heavy objects on cables or bend them excessively. Doing so can damage the cables and lead to fire or electric shock.



Power supply cord

Use the accessory power supply cord when using this camera.



AC adapter

Use the accessory AC adapter when this using this camera.



Do not touch the plug with wet hands. Doing so can lead to electric shock.



Do not attempt to dismantle or modify the camera

Doing so can also lead to damage and even injury, as some internal components become very hot or high voltage. Do not touch parts that are not indicated in this manual.



Do not allow foreign objects

Such as combustible substances, metal objects or water to get inside the camera. These can damage the camera and lead to fire or electric shock.



In the event of an anomaly

such as the image suddenly disappearing or the occurrence of a strange noise, a strange smell or smoke coming from the camera, immediately turn off the power switch and unplug the power supply cord and contact a Hamamatsu subsidiary or your local distributor. Do not attempt to repair the camera yourself.

CAUTION



AC adapter

When unplugging the power supply cord, do not pull on the cord. Remove the plug from the outlet to avoid causing electric shock or fire.



When unplugging the power supply cord, do not pull on the cord, but remove the plug from the camera to avoid breakdown of the AC adapter or the camera.



Connecting and disconnecting cables

Always turn off the power supply of the peripheral device before connecting and disconnecting cables.



Mounting the camera

When mounting the camera to a tripod or other fixture, use the base plate. Be careful that the mounting screw does not enter more than 8 mm from the surface of the base plate. Screwing it in further can impair normal operation.



Mounting the C-mount Lens (C15550-22UP)

Be careful not to screw the lens more than 7 mm into the C-mount of the camera. Doing so can scratch the protective glass. (Some wide-angle lenses in particular can have a thread of 7 mm or more.)



When using F-mount (C15550-22UP01)

An F-mount adapter can be subject to light leaks due to the mating flange mechanism. When used with a high sensitivity, long exposure camera, such as the ORCA-Quest 2, it may be possible to detect photons originating from the F-mount light leakage. In this case, it is recommended to create a dark condition for the camera such as a dark room, dark box or wrap the F-mount flange area with a dark cloth. Be careful maintain the clearance distances in the venting areas of the camera for proper cooling air flow.



Shipping precautions

When transporting the camera by truck, ship, airplane, etc., wrap it securely in packaging material or something similar.



Strong impact

Do not subject the camera to strong shocks (such as dropping it). Doing so can damage the camera.



Operating environment

This camera is designed and tested for use in an industrial environment. If this camera is used in residential areas, EMI (electro-magnetic interference) may occur. This camera must not be used in residential areas.



Disposal

When disposing of the camera, take appropriate measures in compliance with applicable regulations regarding waste disposal and correctly dispose of it yourself, or entrust disposal to a licensed industrial waste disposal company. In any case, be sure to comply with the regulations in your country, state, region or province to ensure the camera is disposed of legally and correctly.

 **CAUTION**

FCC Rules

Note

This device complies with part 15 of the FCC Rules. Operation is subject to the following two conditions: (1) This device may not cause harmful interference, and (2) this device must accept any interference received, including interference that may cause undesired operation.

Note

This equipment has been tested and found to comply with the limits for a Class A digital device, pursuant to part 15 of the FCC Rules. These limits are designed to provide reasonable protection against harmful interference when the equipment is operated in a commercial environment. This equipment generates, uses, and can radiate radio frequency energy and, if not installed and used in accordance with the instruction manual, may cause harmful interference to radio communications. Operation of this equipment in a residential area is likely to cause harmful interference in which case the user will be required to correct the interference at his own expense.

Note

Changes or modifications not expressly approved by the party responsible for compliance could void user's authority to operate the equipment.

⚠ CAUTION



Using water-cooling

Be careful water does not splash on the camera. Cut off the power supply of the circulating water cooler and the camera when you remove and install the cooling water hoses.



Cooling water

It is recommended to use soft water (except pure water) for cooling water. Follow instruction manual which is attached to your circulating water cooler for an appropriate temperature range of cooling water. If you plan on using water other than soft water as recommended for example antifreeze etc, refer to description of cooling water which is written in 12. "MAINTENANCE" or contact a Hamamatsu subsidiary or your local distributor.



Condensation

At the Water-cooling, if ambient temperature and ambient humidity become high, condensation will take place easily. Use the camera under the environment where condensation will not take place referring to the following graph.

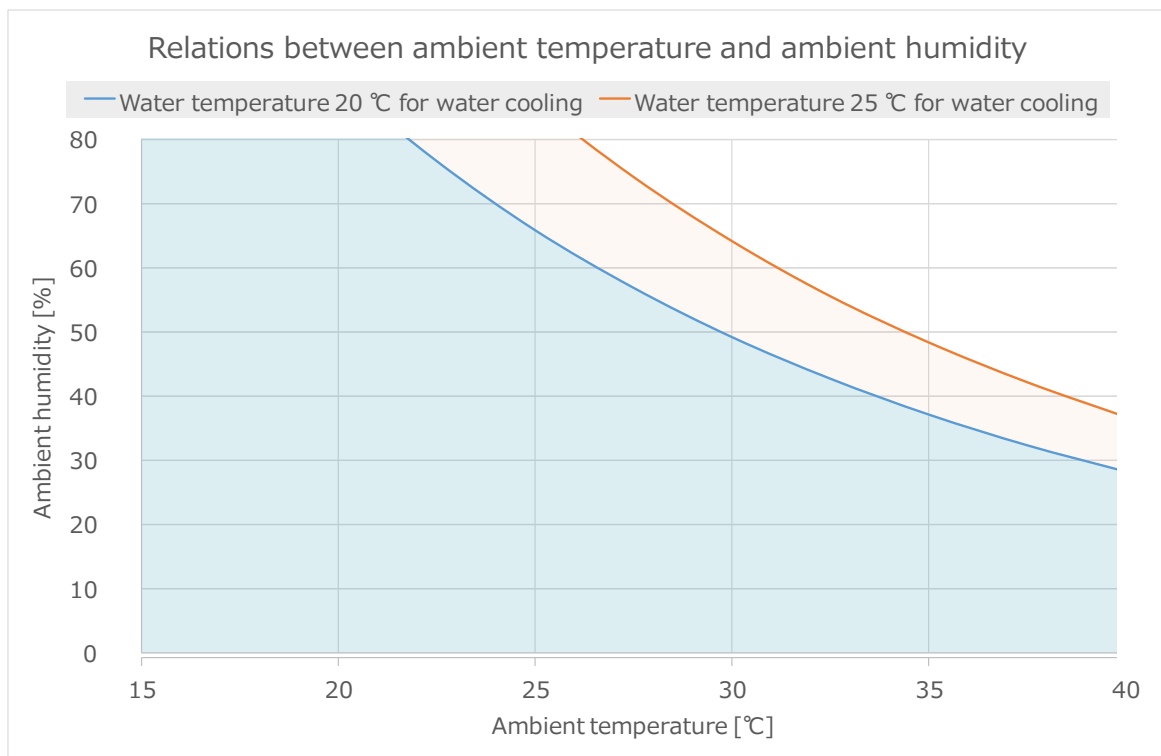

2. CHECK THE CONTENTS OF PACKAGE

When opening the package, check that the following items are included before use. If the contents are incorrect, insufficient or damaged in any way, contact a Hamamatsu subsidiary or your local distributor before attempting to operate the camera.

qCMOS Camera: C15550-22UP or C15550-22UP01	1
AC adapter	1
Power supply cord for AC adapter	1
Lens mount cap (attached to the camera)	1
C15550-22UP / C15550-22UP01 Before Use (Booklet)	1
C15550-22UP / C15550-22UP01 Instruction manual (CD-ROM)	1
QC sheet	1

[Option]

Cooling water hose (2 hoses)	A10788-04
SMA-BNC cable	A12106-05
SMA-SMA cable	A12107-05
CoaXPress interface board	M9982-30
CoaXPress interface cable	A14590-05-40
USB interface board	M9982-25
USB interface cable	A12467-03



- Handle the circulating water cooler and the cooling water according to the instruction manual of the circulating water cooler.

Note

- The cable listed in option is highly recommended for use with the camera. The camera and camera system may not confirm to CE marking and FCC regulations if other type of cable is used with.

Note

- If you use the above options, refer to the each installation manual.

3. INSTALLATION



Avoid using or storing this camera in the following places

- Places where the temperature is not the operating temperature indicated in the specifications
- Places where the temperature is not the storage temperature indicated in the specifications
- Places where the temperature varies greatly
- In direct sunlight or near a heater
- Places where the humidity levels are not the operating humidity levels indicated in the specifications and where the camera may be exposed to liquid
- Places where the humidity levels are not the storage humidity levels indicated in the specifications and where the camera may be exposed to liquid
- Close to a strong source of magnetism or radio waves
- Places where there are vibrations
- Places where the camera may come into contact with corrosive gases (such as chlorine or fluorine)
- Places where there is a lot of dust

How to place the camera (when the camera is placed on a table)



Place the camera with the ventilation ports to sideways.

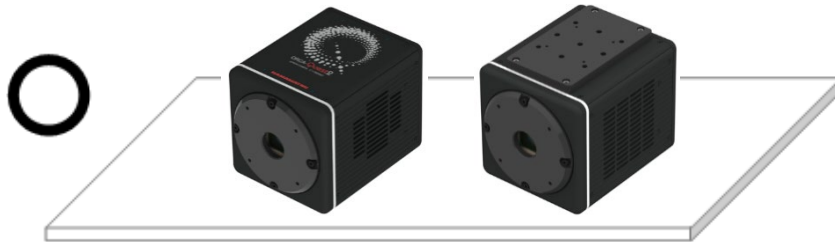

Ensure that there is sufficient airflow through the camera fan.

(Do not block ventilation openings.)

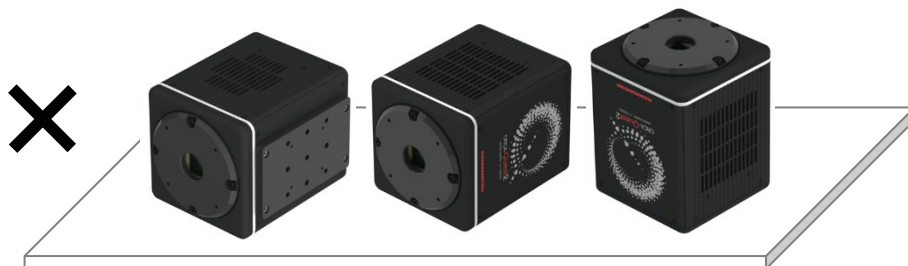

Do not allow the ventilation ports to become blocked.

To prevent the camera from overheating, do not wrap the camera in cloth or any other material, or in any way allow the camera's ventilation ports to become blocked. If the camera is being operated in a closed environment, ensure clearance of at least 10 cm from both the intake and exhaust vents when setting up the camera.



Weight of the camera

Be careful not to drop the camera when moving it as the weights of C15550-22UP and C15550-22UP01 are approx. 3.0 kg and 2.9 kg respectively.

Contents

1. SAFETY PRECAUTIONS	1
1-1 SYMBOLS	1
1-2 CLASSIFICATION OF WARNINGS	1
2. CHECK THE CONTENTS OF PACKAGE	6
3. INSTALLATION	7
4. OVERVIEW	10
5. FEATURES	10
6. NAME AND FUNCTION OF PARTS	13
7. CONNECTION	16
8. WATER COOLING	18
8-1 CAUTIONS	18
8-2 CONNECTION OF WATER COOLING HOSES	20
8-3 DISCONNECTION OF WATER COOLING HOSES	21
9. OPERATIONS	22
9-1 OPERATING PRECAUTIONS	22
9-2 PREPARATING FOR IMAGING.....	23
9-3 IMAGING	23
9-4 END OF IMAGING.....	23
9-5 STARTUP DCAM CONFIGURATOR.....	24
9-6 UPDATE PROCEDURE OF COAXPRESS INTERFACE BOARD.....	26
10. DESCRIPTION OF CMOS IMAGE SENSOR	27
10-1 THEORY OF CMOS IMAGE SENSOR.....	27
10-2 READOUT METHOD OF CMOS IMAGE SENSOR.....	28
10-3 PRECAUTION WHEN USING CMOS IMAGE SENSOR.....	29
11. DESCRIPTION OF VARIOUS FUNCTIONS	30
11-1 AREA READOUT MODE, PHOTON NUMBER RESOLVING MODE.....	30
11-2 LIGHTSHEET READOUT MODE.....	55
11-3 REAL-TIME DEFECT PIXEL CORRECTION	65
11-4 DATA REDUCTION FUNCTIONS.....	66
11-5 MASTER PULSE	67
12. MAINTENANCE	68
12-1 CARE.....	68
12-2 INFORMATION ON COOLING WATER FOR THE CIRCULATING WATER COOLER ..	69

13. TROUBLESHOOTING.....	70
13-1 IMAGE IS NOT TRANSFERRED	70
13-2 ALTHOUGH IMAGES ARE TRANSFFERED	70
14. SPECIFICATIONS	71
14-1 CAMERA SPECIFICATIONS	71
14-2 CONDENSATION.....	74
14-3 SPECTRAL RESPONSE CHARACTERISTICS (TYP.).....	76
15. DIMENSIONAL OUTLINES.....	77
15-1 C15550-22UP	77
15-2 C15550-22UP01	78
16. WARRANTY	79
16-1 BASIC WARRANTY	79
16-2 REPAIRS	79
17. CONTACT INFORMATION	80

4. OVERVIEW

The qCMOS camera (C15550-22UP / C15550-22UP01) utilizes a custom image sensor (quantitative CMOS image sensor: qCMOS) using the latest CMOS design technologies and ultra-small semiconductor technologies and realizes extremely low readout noise (0.30 electrons (r.m.s)). Therefore, photon number resolving is realized within each pixel, enabling superior low light performance and quantitiveness. In addition, the qCMOS camera provides higher speed, lower noise, higher pixelcounts and a better resolution than Gen III sCMOS cameras. Therefore, the qCMOS camera suitable for various applications not only life science microscopy but also physics application like quantum technologies, Astronomy and spectroscopies.

* For more detail information of the qCMOS image sensor and the photon number resolving, refer to the white paper (qCMOS: Quantitative CMOS technologies by Photon Number Resolving)

5. FEATURES

(1) Readout noise

The qCMOS camera adopts the qCMOS image sensor using the latest CMOS design technologies and ultra-small semiconductor technologies and realizes extremely low readout noise (0.30 electrons (r.m.s)).

(2) Photon number resolving capability

Photon number resolving is realized within each pixel, enabling superior low light performance and quantitiveness. The camera has a special mode called "Photon number resolving mode". It can output the digital data as photon number (one digital number per one photoelectron) by quantifying the output digital data from AD converter to photon number with real time image processing. In Photon number resolving mode, Raw data output mode can be selected. This mode outputs the data before converting the photon number. Data output mode can be changed by software which is called, "DCAM Configurator". (refer to 9-5 "STARTUP DCAM CONFIGURATOR").

(3) Pixel number and pixel size

The qCMOS image sensor has 9.4 megapixels. the pixel number is about 1.78 times that of the conventional scientific CMOS image sensor. The pixel size is $4.6 \mu\text{m} \times 4.6 \mu\text{m}$ for high resolution imaging and is smaller than that of the conventional scientific CMOS camera ($6.5 \mu\text{m} \times 6.5 \mu\text{m}$).

(4) Quantum efficiency

The adoption of the back side illuminated and deep trench isolation technologies between pixels improves the quantum efficiency over a wide wavelength range from blue to near-infrared with minimum crosstalk achieving a high quantum efficiency of 85 % and 50 % at 300 nm and 30% at 900 nm wavelength, respectively.

(5) Readout methods

The camera has a variety of readout modes. In addition to full resolution readout mode (1×1), sub-array readout and binning readout (2×2, 4×4) are supported.

(6) Frame rate

This camera realizes both low noise (0.43 electrons (r.m.s)) and high-speed readout (120 fps with 9.4 megapixels) simultaneously, by optimized and accelerated column amplifier and A/D.

(7) Dark current

The state-of-the-art design of the qCMOS image sensor in this camera also achieves low dark current in addition to low readout noise. Innovative cooling technology is implemented on the camera to allow cooling down to -35 °C (when switched to Max cooling). Achieving a dark current of 0.006 electrons/pixel/s makes the camera suitable for long exposure imaging and measurement.

(8) Real-time correction functions

There are a few pixels in CMOS image sensor that have brighter or darker intensity, when compared to surrounding pixels. The camera has a real-time variant (defective) pixel correction feature to further improve image quality. The correction can be performed in real-time without sacrificing any of the readout speed.

(9) Interface

This camera has both CoaXPress interface and USB 3.1 Gen 1 interface.

CoaXPress Interface:

With 6.25 Gbps × 4 lane connection, it is possible to transfer image data of 9.4 megapixels image with 120 fps at standard scan which is the fastest scan mode of this camera. In order to use this interface, a CoaXPress interface board which supports "6.25 Gbps x 4 lane" is required.

USB 3.1 Gen 1 Interface:

USB 3.1 Gen 1 interface is able to transfer a 9.4 megapixels image as a rate of 17.6 fps. It is versatile interface which is suitable to use when fast data transfer is not required. This interface does not require a CoaXPress interface board. It transfers image with moderate transfer speed.



- Do not connect CoaXPress and USB interface simultaneously.



- When a connection interface is changed from CoaXPress to USB, and vice versa, the application software must be closed and the camera must be turned off.

(10) Camera readout modes

The camera has three kinds of readout mode, Area readout mode, Lightsheet readout mode and Photon number resolving mode. The camera also has two scan speed (Standard scan and Ultra quiet scan), and two readout direction in Lightsheet readout mode.

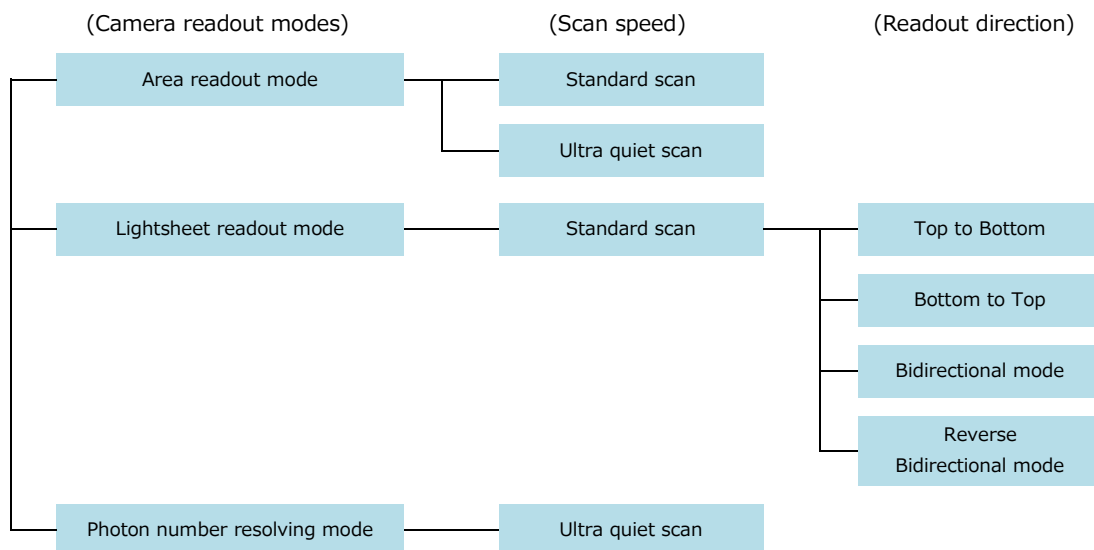

(11) Camera operation modes

The camera has three operation modes: 1) Free running mode, in which the exposure and readout timing are controlled by the internal microprocessor, 2) External trigger mode, in which the exposure and readout timing are decided by an external trigger, and 3) Start trigger mode is used to start operating the camera by a trigger input for a continuous imaging.

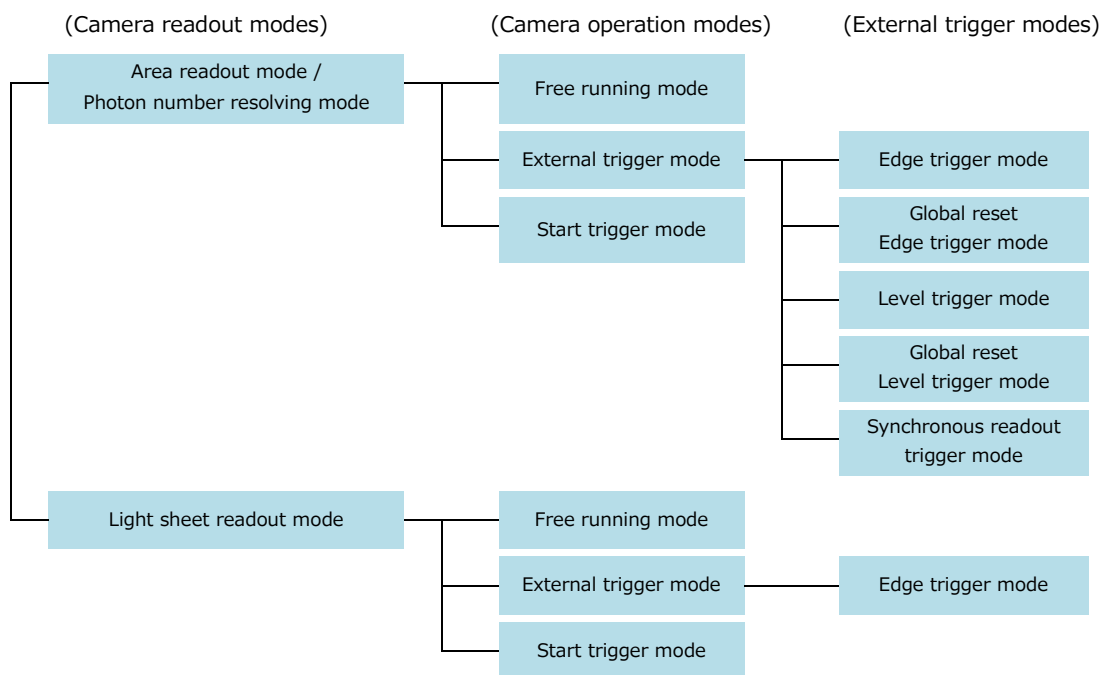

6. NAME AND FUNCTION OF PARTS

(1) C15550-22UP (C-mount type)

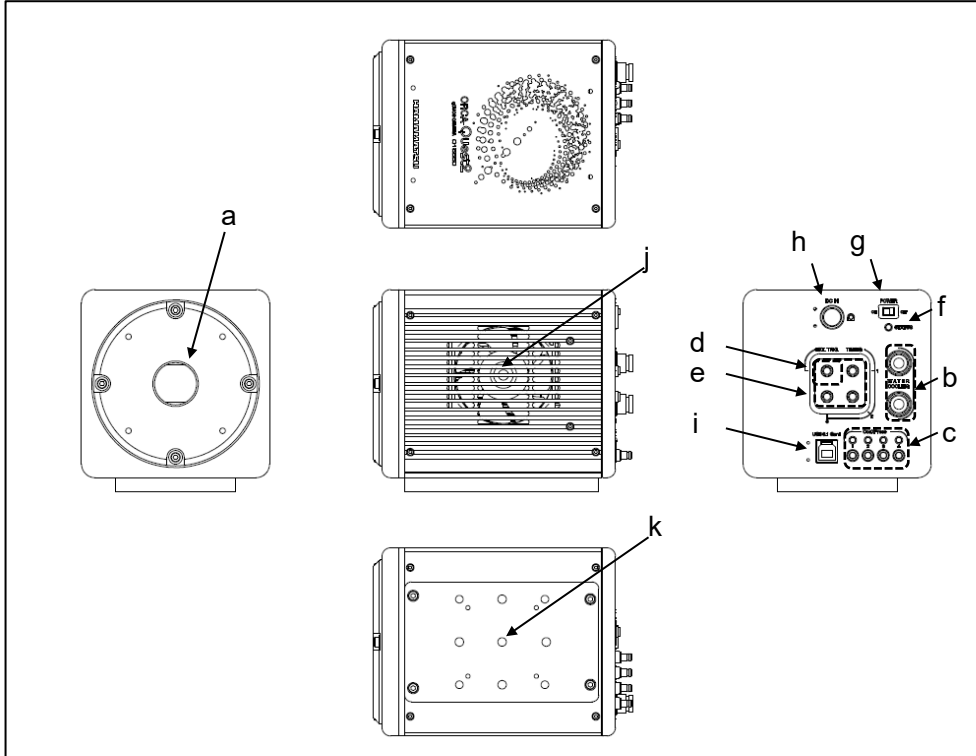

Figure 6-1

(2) C15550-22UP01 (F-mount type)

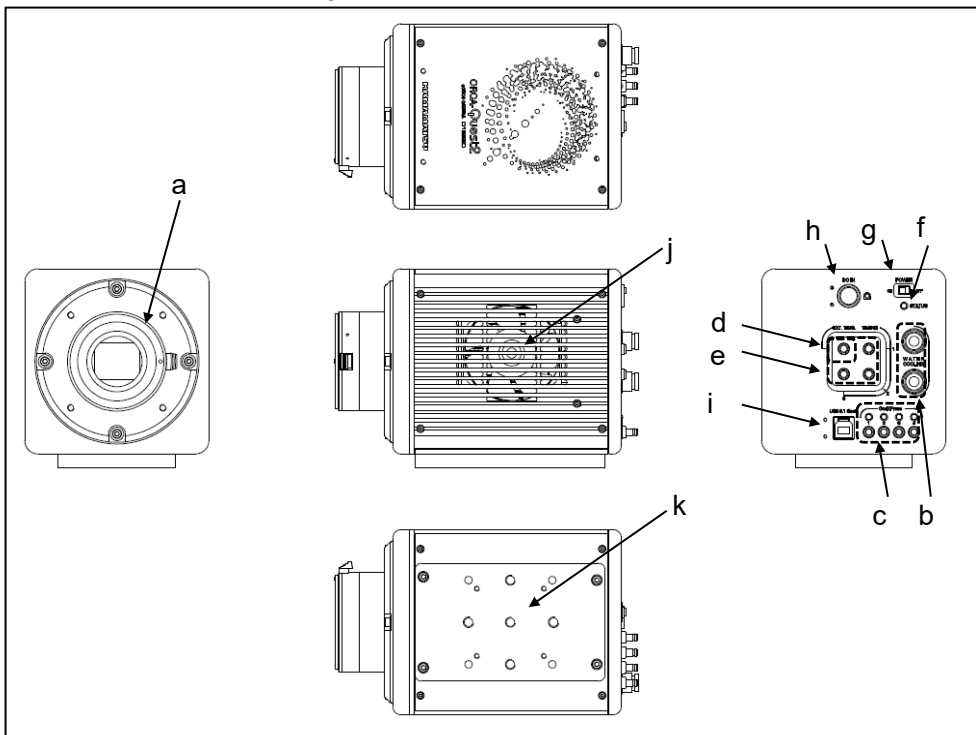



Figure 6-2

 CAUTION	<ul style="list-style-type: none"> Place the camera the ventilation ports to be lateral side. Do not place the rear panel of the camera, which connectors are located, to be at the bottom (Do not block ventilation openings.).
--	---

a. Lens mount

C15550-22UP can be attached to C-mount lens or an optics system.
 C15550-22UP01 can be attached to F-mount lens or an optics system.

Note	<ul style="list-style-type: none"> The depth of the C-mount is 7 mm. Screwing in the C-mount too deeply might scratch the glass surface.
-------------	---



b. WATER connector [WATER] (when using Water-cooling)

It connects the camera and the circulating water cooler with the cooling water hoses. The connector position of WATER IN/OUT is not specified.

 CAUTION	<ul style="list-style-type: none"> See 8 "WATER COOLING" for instruction of water-cooling.
--	---

c. CoaXPress interface connector 1 - 4 [CoaXPress 1 - 4]

The connector 1 to 4 are connected to the CoaXPress interface connector 1 to 4 on the computer, respectively.

	<ul style="list-style-type: none"> When a connection interface is changed from CoaXPress to USB, and vice versa, the application software must be closed and the camera must be turned off.
	<ul style="list-style-type: none"> Do not connect CoaXPress and USB interface simultaneously.

d. Trigger input connector [EXT.TRIG]

This is used when the camera is being operated using external synchronization. Input is TTL or 3.3 V LVCMOS level, and input impedance is 10 kΩ. When an external trigger is input, the trigger is activated at the falling or rising edge of the signal. (You can choose external trigger polarity between Negative and Positive.)

e. Timing out connector 1,2,3 [TIMING 1,2,3]

This is used when peripheral device(s) require synchronization with the camera. Output is 3.3 V LVCMOS level. Output impedance is 33 Ω.

Note	<ul style="list-style-type: none"> Determine termination according to cable length and so on.
-------------	--

f. STATUS lamp [STATUS]

The LED indicates status of camera.

Lighting color	Status of power distribution
Turn off (no color)	Power off
Orange (Blinking)	Initialization
Green (lighting)	Power on
Orange (lighting)	Data transfer
Red (lighting)	Heat up

 CAUTION	<ul style="list-style-type: none"> When the camera heats up, stop operation and unplug the AC adapter immediately.
--	---

g. Power switch [POWER]

The power is turned on/off.

- When the power switch is set to "ON", the camera turns on and starts initialization and the lamp blinks in orange.
- When the initialization is completed, the lamp color stays in green.
- When the camera transfers data, and the lamp color turns orange.
- When the power switch is set to "OFF", the camera returns to the power off state and the lamp turns off.

h. DC power input connector [DC IN]

This is the power supply terminal. Use the accessory AC adapter.

i. USB interface connector [USB 3.1 Gen 1]

This is connected to the USB interface connector on the computer.



- When a connection interface is changed from CoaXPress to USB, and vice versa, the application software must be closed and the camera must be turned off.



- Do not connect CoaXPress and USB interface simultaneously.

j. Air inlet

This is the inlet for the heat ventilation.



- If the camera is being operated in an enclosed environment, ensure to keep clearance at least 10 cm from both intake and exhaust vents when setting up.



- To prevent overheating inside the camera, do not wrap the camera in cloth or other material, or block the camera's ventilation.

k. Base plate

When mounting the camera to a tripod or other fixture, use the base plate.



- The mounting screw does not enter more than 8 mm from the surface of the base plate. Screwing it in further can impair normal operation.

7. CONNECTION

Refer to the figure when connecting the various cables.

(1) CoaXPRESS interface

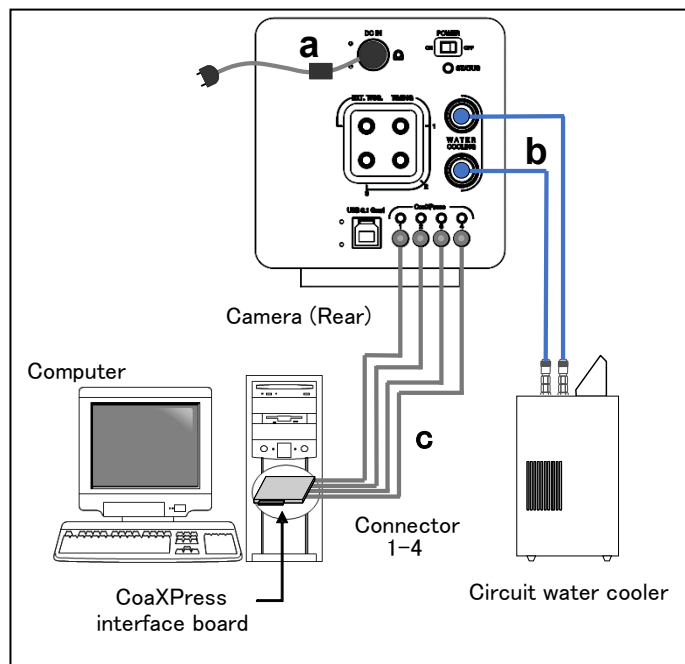

Figure 7-1

(2) USB interface

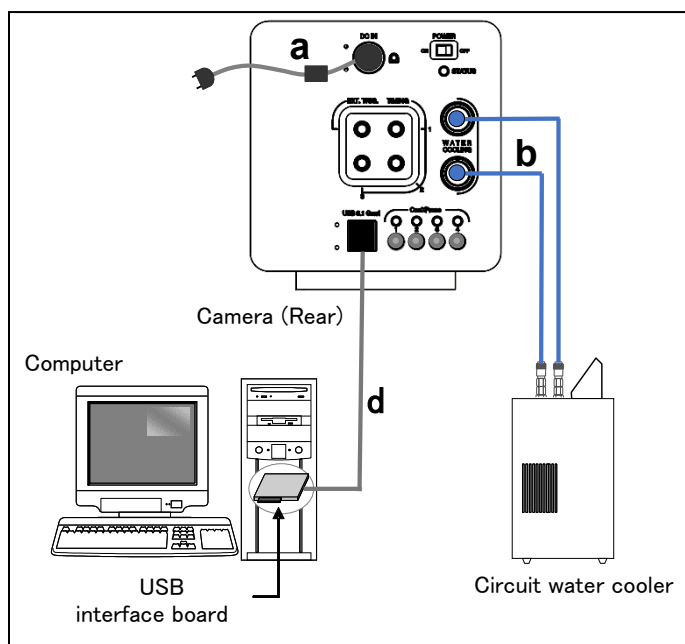



Figure 7-2

 CAUTION	<ul style="list-style-type: none"> Place the camera the ventilation ports to be lateral side. Do not place the rear panel of the camera, which connectors are located, to be at the bottom (Do not block ventilation openings.).
--	---

	<ul style="list-style-type: none"> When you connect cables, turn off the power supply of the camera and the peripheral devices.
Note	<ul style="list-style-type: none"> If you use the above options, see each installation manual.

a. AC adapter

This is the cord to supply a power supply. Use the accessory AC adapter.



b. Cooling water hose (at Water-cooling: Option)

It connects the camera and circulating water cooler. The insert position of WATER IN/OUT on the camera WATER connector is not specified.

 CAUTION	<ul style="list-style-type: none"> See 8 "WATER COOLING" for instruction of water-cooling.
--	---



c. CoaXPress interface cable 1 - 4 (Option)

These are the cables to connect the CoaXPress interface connector 1 to 4 of the camera and the CoaXPress interface connector 1 to 4 on the computer, respectively.

	<ul style="list-style-type: none"> When a connection interface is changed from CoaXPress to USB, and vice versa, the application software must be closed and the camera must be turned off.
	<ul style="list-style-type: none"> Do not connect CoaXPress and USB interface simultaneously.
Note	<ul style="list-style-type: none"> Hamamatsu recommends A14590-05-40 optional CoaXPress interface cable for this camera. The camera complies with EMC and FCC regulations with using A14590-05-40 CoaXPress interface cable. Be careful that the camera with other interface cable may not fulfill the EMC and FCC directive requirements.

d. USB interface cable (Option)

This is the cable to connect the USB interface connector of the camera and the USB interface connector on the computer.

	<ul style="list-style-type: none"> When a connection interface is changed from CoaXPress to USB, and vice versa, the application software must be closed and the camera must be turned off.
	<ul style="list-style-type: none"> Do not connect CoaXPress and USB interface simultaneously.
Note	<ul style="list-style-type: none"> Hamamatsu recommends A12467-03 optional USB interface cable for this camera. The camera complies with EMC and FCC regulations with using A12467-03 USB interface cable. Be careful that the camera with other interface cable may not fulfill the EMC and FCC directive requirements.

8. WATER COOLING

CAUTION

- Improper handling of the camera without observing these cautions could lead to personal injury to the user or damage to property.

8-1 CAUTIONS

(1) Change the cooling method

The default setting of cooling method is Air-cooling. Cooling mode can be changed by software which is called, "DCAM Configurator". (Refer to 9-5 "STARTUP DCAM CONFIGURATOR").

(2) Cooling water

It is recommended to use soft water (except pure water) for cooling water.

If you plan on using water other than soft water as recommended for example antifreeze etc, refer to description of cooling water which is written in 12. "MAINTENANCE" or contact a Hamamatsu subsidiary or your local distributor.

(3) Recommendation temperature

Hamamatsu recommends 25 °C for Circulating water temperature.

For the appropriate temperature range of the cooling water, confirm with the instruction manual of your circulating water cooler.

(4) Condensation

Use the camera under the environment where condensation will not take place referring to the following graph.

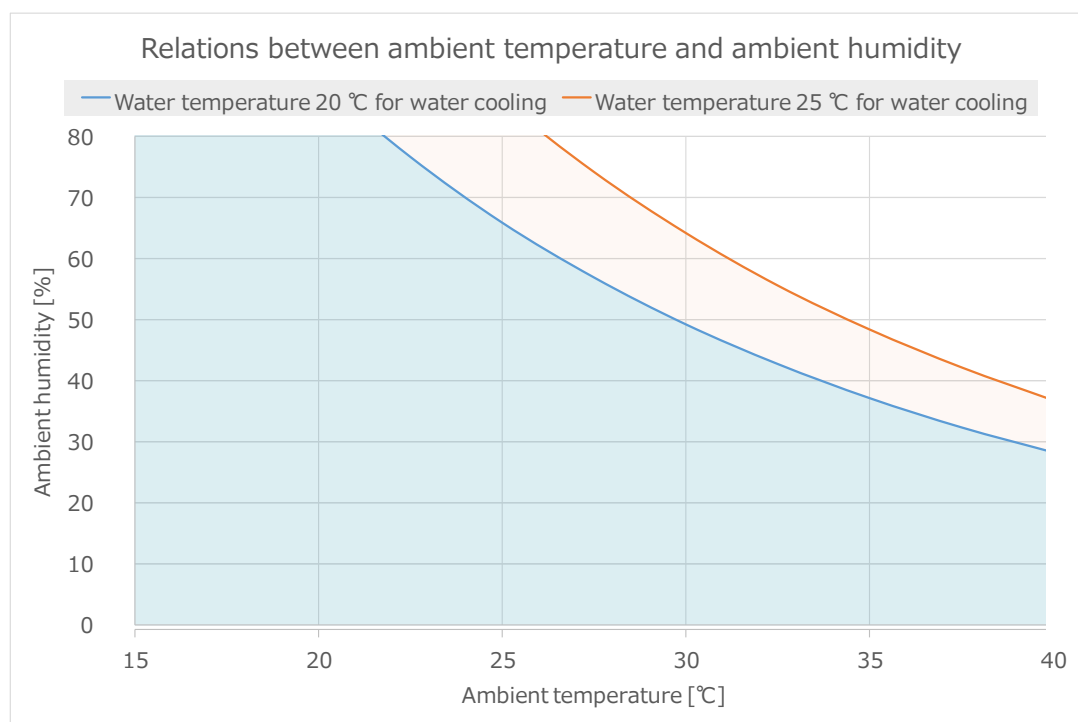

Graph 8-1

(5) Handling of the circulating water cooler

Handle the circulating water cooler and the cooling water according to an instruction manual of the circulating water cooler.

Proper performance may not be achievable if a non-recommended circulating water cooler is used.

(6) Start water-cooling and water-cooling in operation

- Confirm the water is flowing before starting the camera cooling and that the camera does cool.
- Keep 0.45 L/min flow rate for water circulation.
- Do not stop the circulating water cooler while the camera is working.

(7) Cooling water hose

The hose has a blue hose (Internal diameter: 4 mm / External diameter: 6 mm) and a gray hose (Internal diameter: 8 mm / External diameter: 13.5 mm). (Figure 8-1)

If the hose size on circulating water cooler is the same as blue hose, remove gray hose from the joint part. The gray hose can be removed when blue hose is pulled with pushing the button of the joint on gray hose. (Figure 8-2)

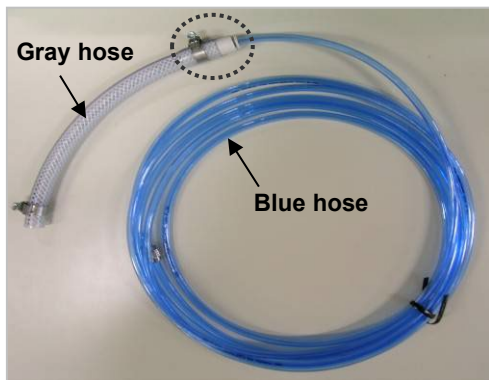

Figure 8-1

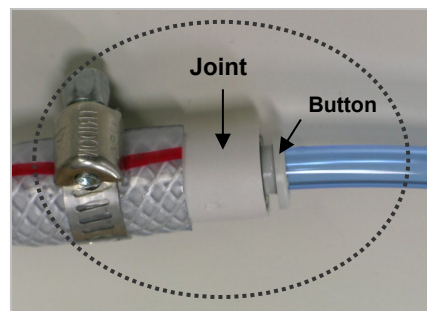



Figure 8-2

(8) Connection of the cooling water hose

 CAUTION	<ul style="list-style-type: none"> • Follow the instruction in Section 8-2 “CONNECTION OF WATER COOLING HOSES” and Section 8-3 “DISCONNECTION OF WATER COOLING HOSES” to connect / disconnect the hose.
--	--

- Stop water circulation when connecting / disconnecting the hose, and turn off the power of the camera and the circulating water cooler.
- Confirm that cooling water stops.
- Prepare water absorption sheet (such as Waste, Towel or so) and catch pan in order to avoid water drop or water splash.

(9) Deterioration of the cooling water hose

Replace the water hose with a new one whenever it cannot keep 0.45 L/min flow rate for water circulation due to the hose deterioration.

8-2 CONNECTION OF WATER COOLING HOSES

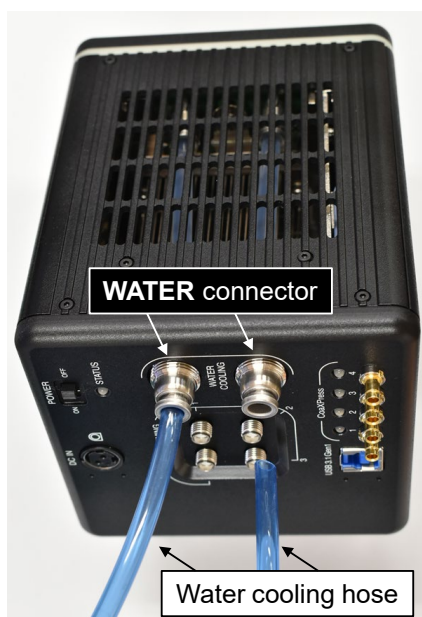

Figure 8-3

1. Place the camera on the stable table.
2. Connect water cooling hose into the WATER connector on the camera.
 - Insert the hose fully into the WATER connector on the camera. (as shown in Figure 8-3)
 - Confirm the hose stops at it.
3. Set the camera onto a microscope (If the camera is used on the microscope).

If it is easy to connect the hose onto the camera after the camera is set onto the microscope then it is OK to connect the hose after the camera is set on the microscope.
4. Connect the hose onto the circulating water cooler.

Follow the instruction on the circulating water cooler when you connect the hose onto the circulating water cooler.
5. Turn on the circulating water cooler and confirm the cooling water is flowing normally.



CAUTION

- Stop the circulating water cooler when the water flow is abnormal or water drop or splash is found.

8-3 DISCONNECTION OF WATER COOLING HOSES

<p>⚠ CAUTION</p>	<ul style="list-style-type: none"> Remove the water cooling hoses only when it is necessary to remove.
<p>⚠ CAUTION</p>	<ul style="list-style-type: none"> Cooling water may be left inside the camera even after hoses are removed. In such case, remove water inside by blowing air from connectors. Be careful not to splash water onto the camera.

1. Turn off the camera power and all peripheral devices including circulating water cooler.
2. Remove the hose on circulating water cooler side.
Follow the instruction on the circulating water cooler when you disconnect the hose from the circulating water cooler.
3. Remove water or water drop inside the hose and the camera by air.
 - Blow air from one side of hose. Prepare water absorption sheet (such as Waste, Towel or so) and catch pan on another side of hose in order to avoid water drop or water splash.
 - Blow Air until no water drop come out.
4. Remove the camera from the microscope (if the camera is used on the microscope).
It is not necessary to remove the camera from the microscope if it is possible to remove the hoses from the camera as it is.
5. Place the camera on the stable table.
Put the lens cap on to protect the sensor.
6. Change the WATER connector direction to be downward.
Prepare water absorption sheet (such as Waste, Towel or so) and catch pan.
7. Remove hoses one by one, and wipe water.
Disconnect hoses with pushing button while being careful not to splash water.

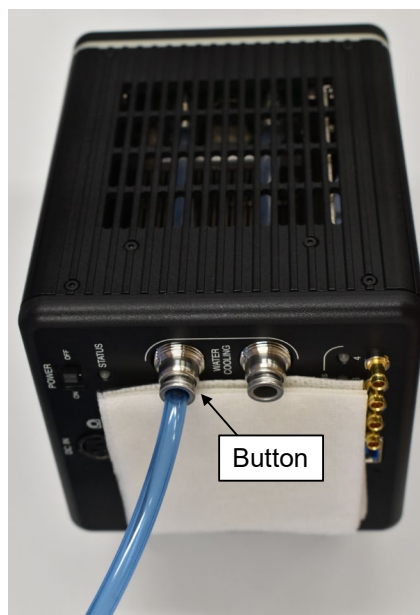

Figure 8-4

9. OPERATIONS

9-1 OPERATING PRECAUTIONS

Be careful of the following when you operate the camera.

(1) Cooling method

Cooling of this equipment is done using a Peltier element.

With a Peltier element, when current is supplied, one surface is cooled, and the other surface is heated. CMOS image sensor is positioned on the cooled side, and cooling is done by discharging the heat from the heated surface.

The camera has two cooling methods, Air-cooling method and Water-cooling method.

The default of cooling method is Air-cooling. Cooling mode can be changed by software which is called, "DCAM Configurator". (refer to 9-5 "STARTUP DCAM CONFIGURATOR").

Cooling method	Detail
Air-cooling method (Forced air-cooled) (Default)	The heated side of a peltier element is cooled by a fan inside the camera. When the camera is turned on, the fan starts rotating and cooling is started.
Water-cooling method	Circulating water cooler (Optional) is used for cooling the heated side of a peltier element. Cooling does not start just turning on the camera. Cooling water circulation must be started before start operating the camera in water-cooling. A fan inside the camera does not rotate.

 CAUTION	<ul style="list-style-type: none"> See 8 "WATER COOLING" for instruction of water-cooling.
--	---



- Do not switch to water-cooling method when water-cooling is unnecessary.

(2) Ambient temperature

The recommended ambient temperature for camera operation is 25 °C.

Both water-cooling or air-cooling are available as cooling method, CMOS image sensor cooling temperature is more stable under water cooling operation.

(3) Protection circuit

This camera's thermoelectric cooling device is protected by a thermal protection circuit.

If the internal temperature of the camera becomes abnormally hot, the protection circuit operates to inform the user by a buzzer alarm (beep tone) and lighting the camera red LED light while simultaneously cutting the current supply to the Peltier element. As soon as this protection is implemented, turn off the power switch, unplug the AC supply. Then remove the cause of the overheating.

(4) CoaXPress interface board

If you use an optional CoaXPress interface board, a message prompting update of the interface board may be displayed. In this case, an update procedure manual will be displayed when you click on the message. Update the interface board according to the procedure manual. (refer to 9-6 "UPDATE PROCEDURE OF COAXPRESS INTERFACE BOARD").

9-2 PREPARATING FOR IMAGING

Use the following procedure when start operating the camera.



- When you connect cables, turn off the power supply of the camera and the peripheral devices.

Note

- After cooling mode was changed, the camera memorizes the last setting as the default setting for cooling. The present cooling mode set-up of this camera can be checked using "DCAM Configurator". (refer to 9-5 "STARTUP DCAM CONFIGURATOR")

Note

- When using F-mount (C15550-22UP01), an F-mount adapter can be subject to light leaks due to the mating flange mechanism. When used with a high sensitivity, long exposure camera, such the ORCA-Quest 2, it may be possible to detect photons originating from the F-mount light leakage. In this case, it is recommended to create a dark condition for the camera such as a dark room, dark box or wrap the F-mount flange area with a dark cloth. Be careful maintain the clearance distances in the venting areas of the camera for proper cooling air flow.

9-2-1 WHEN USING AIR-COOLING

1. Connect the equipment as shown in Figure 7-1 before operating of the camera.
2. Turn on the camera.
3. Check cooling fan is operating properly and air is circulating.



- When cooling method of the camera is set by water-cooling method, the fan does not start rotating.

9-2-2 WHEN USING WATER-COOLING

1. Connect the equipment as shown in Figure 7-1 before operating of the camera.
2. Turn on the circulating water cooler.
3. Check cooling water is circulating properly.
4. Turn on the camera.
5. Turn on the cooling switch of the camera from application software.

Note

- Refer to the manual of application software for ON/OFF of the cooling switch of a camera.

9-3 IMAGING

Operate the camera from application software.

9-4 END OF IMAGING

Follow the procedure below when imaging is finished.

1. End the imaging or transmission of image data with the application software.
2. Turn off the camera and peripheral devices.
3. Turn off the circulating water cooler. (at water-cooling)

9-5 STARTUP DCAM CONFIGURATOR

The following is a procedure to startup “DCAM Configurator”.

1. Open “Setup.exe” in the DCAM-API software’s folder.
If the DCAM-API software is not installed on your computer, insert the media of DCAM-API software in the slot of your computer.
When it is inserted, “DCAM-API Setup” window is displayed automatically.
2. Click on “Tools”.

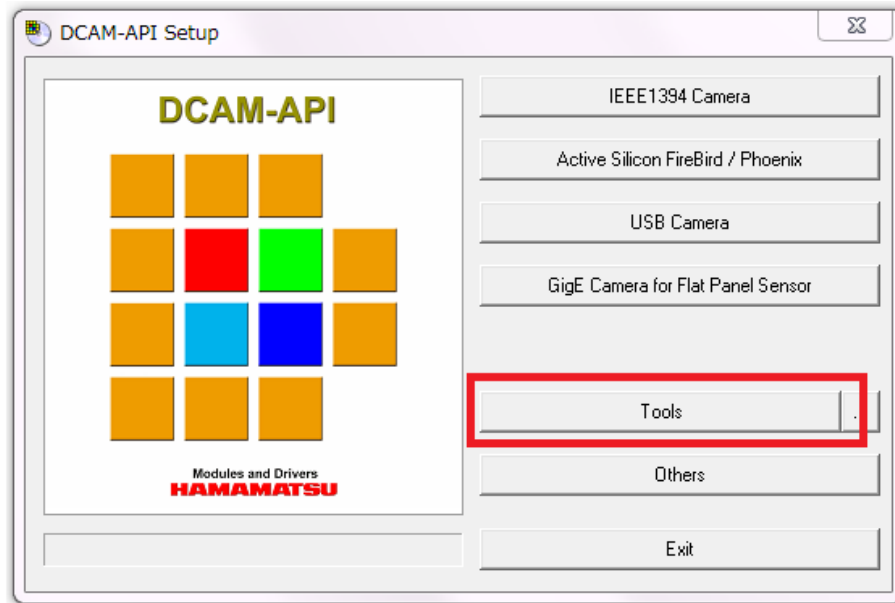

3. Click on “DCAM Configurator”.

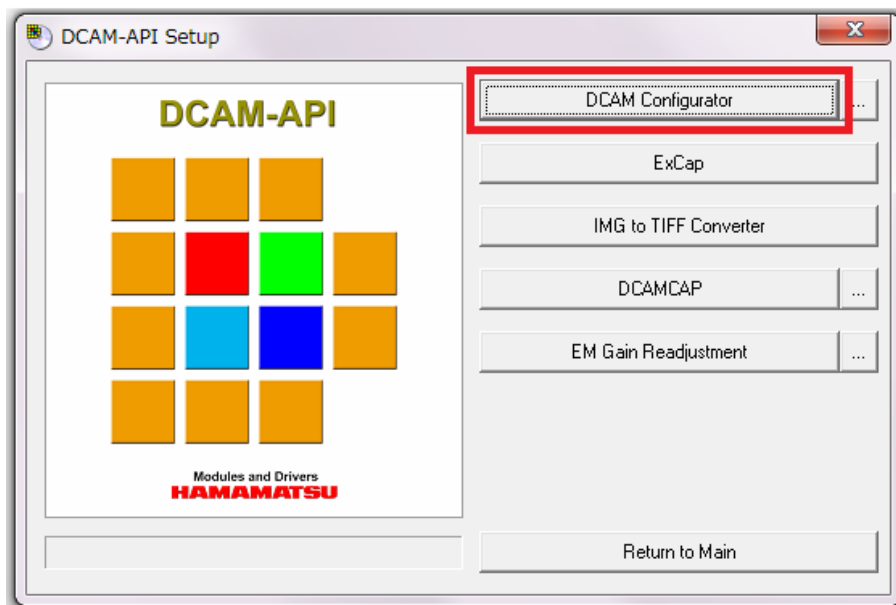

4. "DCAM Configurator" window is displayed. The startup is completed with this.

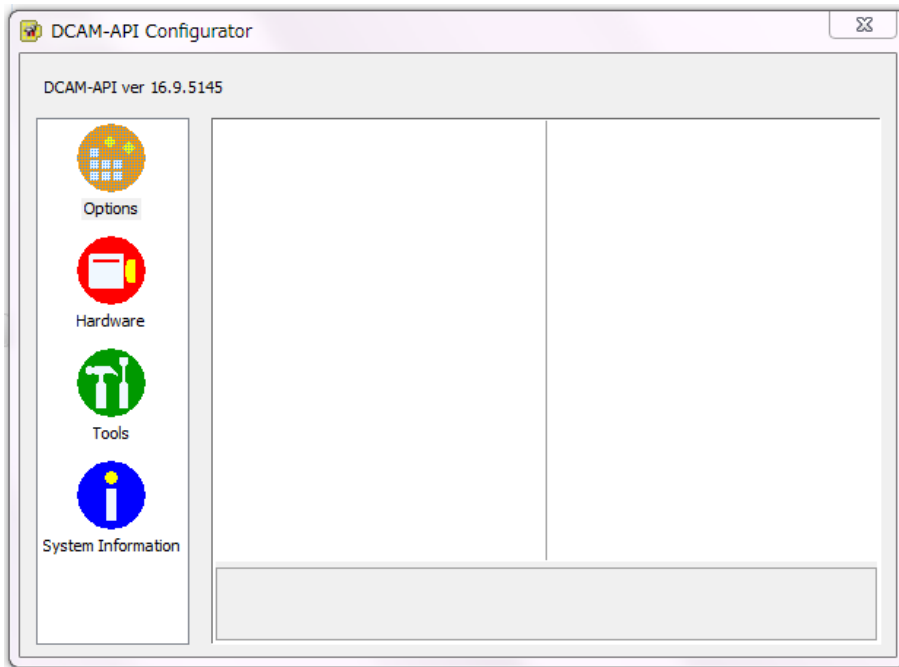

- Even if the camera's power supply is turned off, the state of setting is kept.
- The state of setting can confirm according to "Hardware" icon on DCAM Configurator window.



Hardware

- After the startup, operate DCAM Configurator according to "DCAM Configurator Instruction manual". The manual is displayed when the following buttons on DCAM Setup window are clicked.

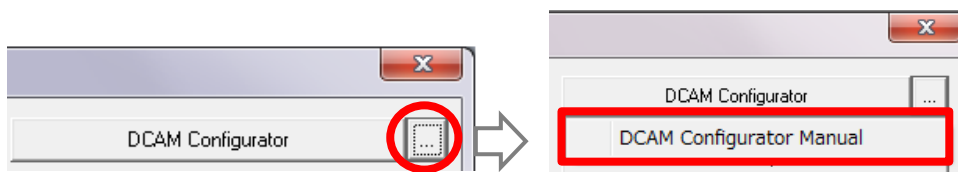

9-6 UPDATE PROCEDURE OF COAXPRESS INTERFACE BOARD

If you use an optional CoaXPress interface board, when the driver included in DCAM-API does not match the firmware version of the interface board, the following message prompting update of the interface board may be displayed.

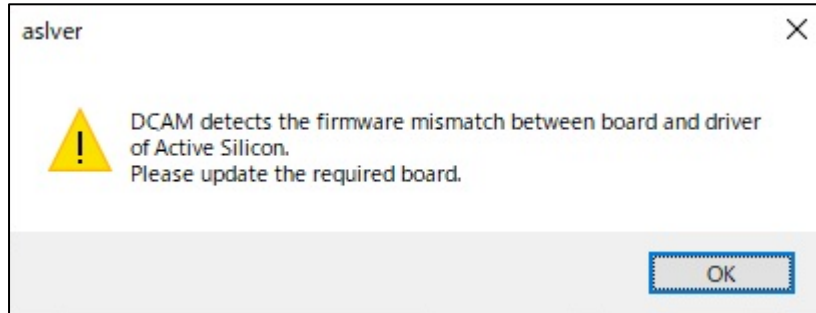

When this message is displayed, you need to update the firmware of the interface board to use the connected camera. In this case, an update procedure will be displayed on the screen when you click "OK". Update the interface board according to it.

Note

- The displayed message may vary depending on the version of DCAM-API used.

10. DESCRIPTION OF CMOS IMAGE SENSOR

10-1 THEORY OF CMOS IMAGE SENSOR

The pixel of a CMOS image sensor is composed of the photodiode and the amplifier that converts the charge into voltage. Entered light is converted to charge and converted to voltage in the pixel. The voltage of each pixel is output by switching the switch one by one. (Figure 10-1)

The scientific CMOS image sensor used in this camera has an on-chip CDS (correlated double sampling) circuit, which plays an important role in achieving low noise. In addition, column amplifiers and A/Ds are adopted for odd row pixels and even row pixels, respectively. For this reason, 2 line parallel readout is conducted and both low noise and high speed readout are provided simultaneously.

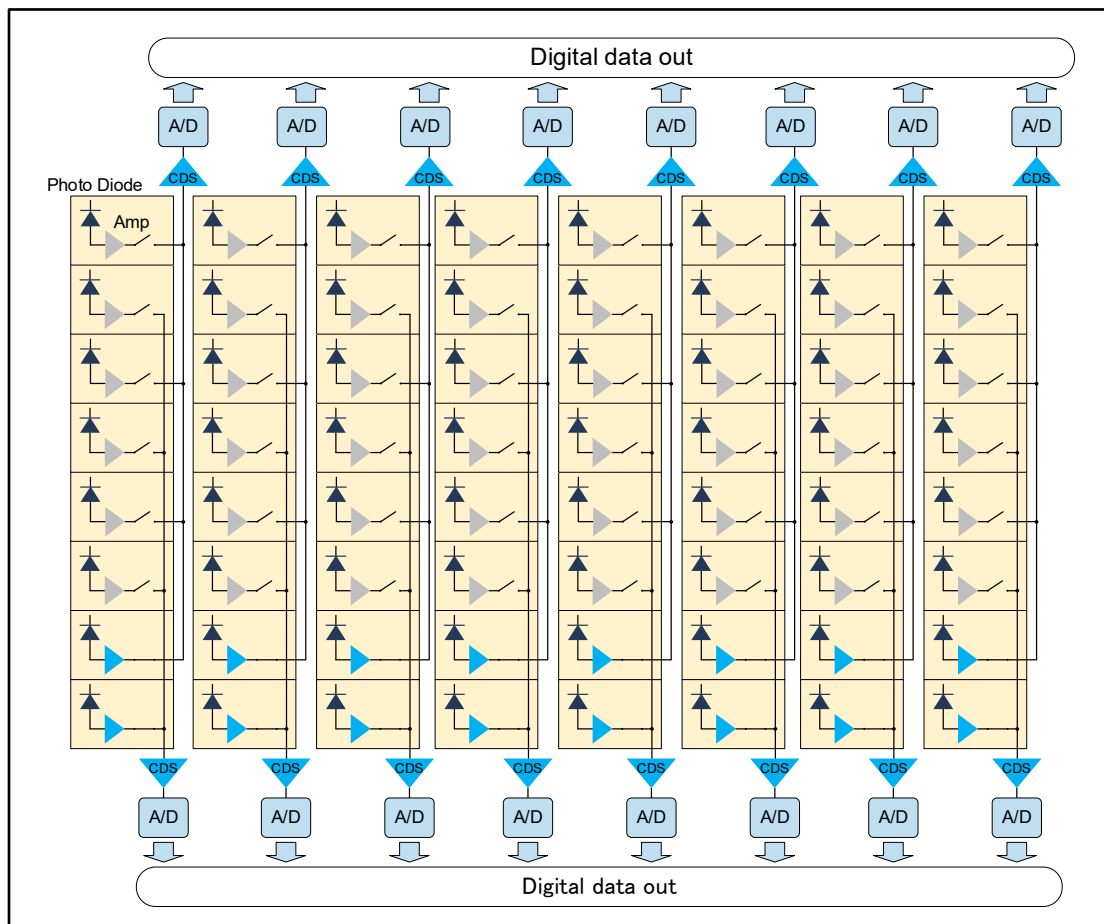

Figure 10-1 Structure of CMOS image sensor

10-2 READOUT METHOD OF CMOS IMAGE SENSOR

The qCMOS camera adopts a rolling shutter readout for high speed imaging. In the camera, the odd and even lines are read out in pairs, therefore the exposure and readout timing is slightly delayed as the readout moves down the sensor (Figure 10-2). The affect of the rolling shutter timing is very small for most exposure times.

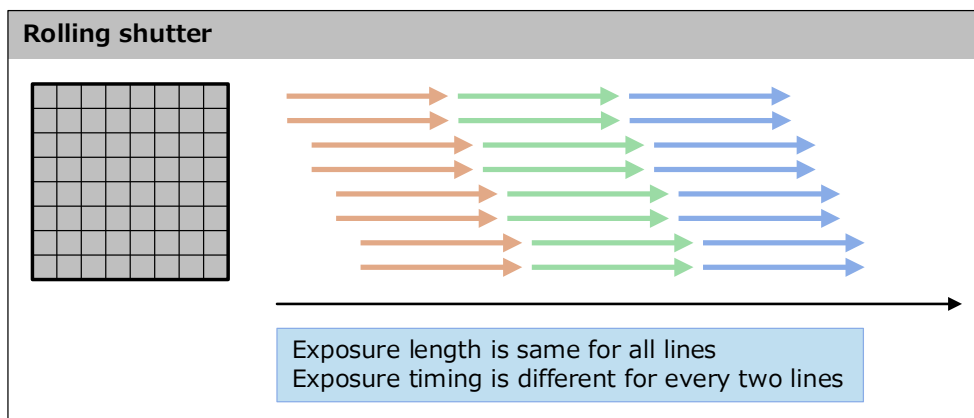

Figure 10-2 Readout timing of Rolling shutter

10-3 PRECAUTION WHEN USING CMOS IMAGE SENSOR

This camera uses scientific CMOS image sensor. Careful attention must be paid to the following points when using CMOS image sensor.

(1) White spot

CMOS image sensor has some high dark current pixels caused by the defect of silicon wafer. Those high dark current pixels appear as higher intensity and brighter pixels than around pixels when the exposure time is set long. Those pixels are called as “White spot” (“hot pixel”).

This camera has real time defect pixel correction function which can replace the defect pixels registered in advance with the data of surrounding pixels.

Hitting of cosmic ray or radiation ray (X-ray, gamma ray, UV light, etc.) on the sensor generates many electrons and they may appear as a white spot, but this white spot is temporary and disappear in the next frame.

In addition, although the probability is very low, the impact of cosmic rays and radiation (X-rays, gamma rays, ultraviolet rays, etc.) is large, and it may cause permanent defects in silicon wafers and defective pixels with large dark current. In current technology, there is no way to avoid generating high dark current defect pixels. It means there is a possibility to generate new white spots after the factory shipment.

Even if the white spot occurs, dark offset subtraction* with software can reduce the effect of white spots because intensities of white spots are proportional to the exposure time and have reproducibility with a constant sensor temperature.

* Dark subtraction: After acquiring an image using a certain exposure time is loaded, CMOS image sensor is exposed to darkness for the same amount of time, and another image is obtained. After this, the difference between the images is determined, and the data for the dark portion of the original image is nullified.

(2) Folding distortion

A rough-edged flicker may be visible when imaging striped patterns, lines, and similar subject matter.

(3) Over light

 CAUTION	• Be careful not to input too strong light such as high-energy laser into CMOS image sensor because CMOS image sensor may be damaged by over light.
--	---

11. DESCRIPTION OF VARIOUS FUNCTIONS

11-1 AREA READOUT MODE, PHOTON NUMBER RESOLVING MODE

11-1-1 CAMERA READOUT MODES (READOUT DIRECTION)

The camera reads out in two line pairs simultaneously.

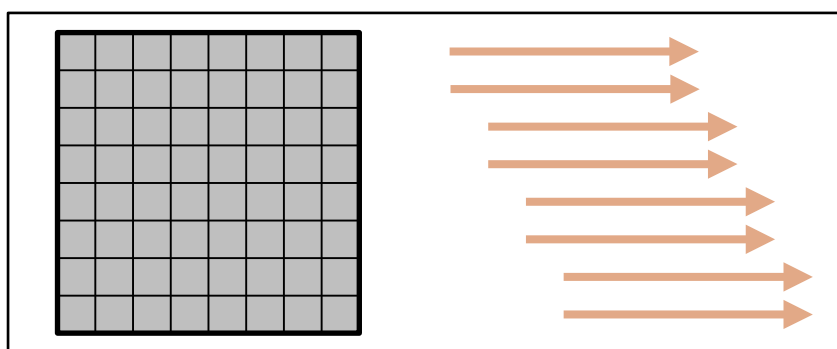

Figure 11-1 Readout direction of Area readout mode

11-1-2 READOUT METHODS

(1) Full resolution readout mode (1×1 readout)

Perform charge readout from camera individually for all pixels.

(2) Binning readout (2×2 / 4×4 readout)

With this camera, 2×2 binning readout and 4×4 binning are available by adding the signal of adjacent pixels in the digital domain. Binning readout is a method for achieving high sensitivity in exchange for losing resolution.

In Photon number resolving mode, 2×2, and 4×4 binning are available and implemented after the photon number is resolved for each pixel.

Output bit depth / binning	OFF	2×2	4×4
16 bit	200 counts	800 counts	3200 counts
12 bit	200 counts	800 counts	3200 counts
8 bit	200 counts	200 counts	200 counts

(3) Sub-array readout

Sub-array readout is a procedure where only a region of interest is scanned. It is possible to increase the frame rate by reducing the number of vertical lines scanned. In sub-array readout, binning can also be enabled.

Size and a position of the readout area can be configured according to the table below.

Size		Position	
Horizontal	Vertical	Horizontal	Vertical
4 pixels	4 lines	4 pixels	4 lines

Note

- Minimum settable step of the size and position on the table is in only the case that the camera is used with DCAM-API.

Note

- Refer to 11-1-4 "FRAME RATE CALCULATION" about the frame rate of each readout mode.

11-1-3 READOUT SPEED (SCAN SPEED)

The Standard scan readout speed can achieve a frame rate of 120 fps for full resolution with low noise (0.43 electrons (r.m.s.)) and the Ultra quiet scan readout speed can achieve extremely low noise (0.30 electrons (r.m.s.)).

The CoaXPress interface is required to transfer the full resolution image data at the full speed of 120 frames per second. When you use USB interface, a maximum of 17.6 fps is achievable for full resolution. The frame rate with USB interface can be faster if you reduce the digital output to 12 bit or 8 bit data.

Scan speed	Digital output	Frame rate for full resolution	
		CoaXPress	USB
Standard scan	16 bit	120 fps	17.6 fps
	12 bit		23.5 fps
	8 bit		35.3 fps
Ultra quiet scan	16 bit	25.4 fps	17.6 fps
	12 bit		23.5 fps
	8 bit		25.4 fps

Note

- Refer to 11-1-4 "FRAME RATE CALCULATION" about the frame rate of each readout mode.

Note

- Ultra quiet mode is used for the Photon number resolving mode.

11-1-4 FRAME RATE CALCULATION

(1) Standard scan: CoaXPress

Exp1 = 7.2 μ s to 1800 s (input in units of seconds)
 1H = 7.2 μ s
 Exp2 = ROUNDUP (Exp1 / 1H) * Round up to integer
 Vn1 = Number of vertical lines
 Vn2 = (Vn1 / 2) + 5

Conditions		Vn3
Exp2 < 13 889	Exp2 < Vn2	0
	Exp2 \geq Vn2	Exp2 - Vn2 + 1
Exp2 \geq 13 889		0

Vn4 = MAX (Vn2, Exp2)
 Vn4 = MAX (Vn2 + 2, Exp2)

Operation modes	Calculation formula	Horizontal	Vertical	Max frame rate (fps)
Free running mode	If (Exp2 < 13 889): 1 / (Vn2 + Vn3) / 1H Others: 1 / Exp2 / 1H	4096	2304	120
			2048	134
			1024	268
			512	532
			256	1040
			8	15 400
External trigger mode (Edge trigger)	If (Vn4 = Vn2) 1 / (Vn4 + 1) / 1H Others: 1 / (Vn4 + 2) / 1H	4096	2304	119
			2048	134
			1024	268
			512	530
			256	1030
			8	13 800
External trigger mode (Level trigger / Global reset edge trigger / Global reset level trigger)	1 / (Vn2 + Exp2 + 3) / 1H	4096	2304	119
			2048	134
			1024	266
			512	524
			256	1013
			8	10 683
External trigger mode (Synchronous readout trigger)	1 / (Vn5 + 1) / 1H	4096	2304	119
			2048	134
			1024	267
			512	526
			256	1021
			8	11 574
			4	13 888

Note

- The frame rate value is valid 3 digits and rounded down to 4th digit.

Note

- The calculation formula and the frame rate value of Start trigger mode (External trigger mode) are same as Free running mode. About this mode, refer to 11-1-6-3 "Start trigger mode".

Note

- The calculation formula and the frame rate value do not depend on the bit depth of digital output.

Note

- Ultra quiet mode is used for the Photon number resolving mode.

(2) Standard scan: USB

Exp1 = 7.2 μ s to 1800 s (input in units of seconds)

1H = 7.2 μ s

Exp2 = ROUNDUP (Exp1 / 1H) * Round up to integer

Hn1 = Number of horizontal lines (Binning OFF)

BN = Binning setting

Output bit depth	BW = Interface band width
16 bit	167 473 152
12 bit	223 297 536
8 bit	334 946 304

Vn1 = Number of vertical line (Binning OFF)

Vn2 = $Vn2 = (Vn1 + 6) / 2 + 2$

Vn3 = ROUNDUP (Hn1 * (Vn1 + 6) / BW / BN² / 1H)

Vn4 = MAX (Vn2, Vn3)

Conditions		Vn5
Exp2 < 13 889	Exp2 < Vn2	Vn4
	Exp2 \geq Vn2	Exp2 + 1
Exp2 \geq 13 889		0

Vn6 = MAX (Vn4, Exp2)

Vn7 = MAX (Vn2 + 2, Vn4, Exp2)

1. 16 bit digital output

Operation modes	Binning	Calculation formula	Hn \times Vn	Max frame rate (fps)
Free running mode	1 \times 1	If (Exp2 < 13 889): 1 / Vn5 / 1H Others: 1 / Exp2 / 1H	4096 \times 2304	17.6
			2048 \times 2048	39.8
			1024 \times 1024	158
			512 \times 512	532
			256 \times 256	1040
			256 \times 8	15 400
			256 \times 4	19 800
	2 \times 2		2048 \times 1152	70.7
	4 \times 4		1024 \times 576	120
External trigger mode (Edge trigger)	1 \times 1	If (Vn6 = Vn4) 1 / (Vn6 + 1) / 1H Others: 1 / (Vn6 + 2) / 1H	4096 \times 2304	17.6
			2048 \times 2048	39.7
			1024 \times 1024	158
			512 \times 512	530
			256 \times 256	1030
			256 \times 8	13 800
			256 \times 4	17 300
	2 \times 2		2048 \times 1152	70.7
	4 \times 4		1024 \times 576	119
External trigger mode (Level trigger / Global reset edge trigger / Global reset level trigger)	1 \times 1	If (Vn2 + Exp2 + 2 < V4): 1 / (Vn4 + 1) / 1H Others: 1 / (Vn2 + Exp2 + 3) / 1H	4096 \times 2304	17.6
			2048 \times 2048	39.7
			1024 \times 1024	158
			512 \times 512	524
			256 \times 256	1010
			256 \times 8	10 600
			256 \times 4	12 600
	2 \times 2		2048 \times 1152	70.7
	4 \times 4		1024 \times 576	119

Operation modes	Binning	Calculation formula	Hn × Vn	Max frame rate (fps)
External trigger mode (Synchronous readout trigger)	1×1	$1 / (Vn7 + 1) / 1H$	4096 × 2304	17.6
			2048 × 2048	39.7
			1024 × 1024	158
			512 × 512	526
			256 × 256	1020
			256 × 8	11 500
			256 × 4	13 800
	2×2		2048 × 1152	70.7
	4×4		1024 × 576	119

- Note**
 - The frame rate value is valid 3 digits and rounded down to 4th digit.
- Note**
 - The calculation formula and the frame rate value of Start trigger mode (External trigger mode) are same as Free running mode. About this mode, refer to 11-1-6-3 "Start trigger mode".
- Note**
 - Ultra quiet mode is used for the Photon number resolving mode.

2. 12 bit digital output

Operation modes	Binning	Calculation formula	Hn × Vn	Max frame rate (fps)
Free running mode	1×1	If (Exp2 < 13 889): 1 / (Vn2 + Vn5) / 1H Others: 1 / Exp2 / 1H	4096 × 2304	23.5
			2048 × 2048	53.0
			1024 × 1024	211
			512 × 512	532
			256 × 256	1040
			256 × 8	15 400
			256 × 4	19 800
			2048 × 1152	94.3
			1024 × 576	120
External trigger mode (Edge trigger)	1 × 1	If (Vn6 = Vn4) 1 / (Vn6 + 1) / 1H Others: 1 / (Vn6 + 2) / 1H	4096 × 2304	23.5
			2048 × 2048	53.0
			1024 × 1024	211
			512 × 512	530
			256 × 256	1030
			256 × 8	13 800
			256 × 4	17 300
			2048 × 1152	94.2
			1024 × 576	119
External trigger mode (Level trigger / Global reset edge trigger / Global reset level trigger)	1×1	If (Vn2 + Exp2 + 2 < V4): 1 / (Vn4 + 1) / 1H Others: 1 / (Vn2 + Exp2 + 3) / 1H	4096 × 2304	23.5
			2048 × 2048	53.0
			1024 × 1024	211
			512 × 512	524
			256 × 256	1010
			256 × 8	10 600
			256 × 4	12 600
			2048 × 1152	94.2
			1024 × 576	119
External trigger mode (Synchronous readout trigger)	1×1	1 / (Vn7 + 1) / 1H	4096 × 2304	23.5
			2048 × 2048	53.0
			1024 × 1024	211
			512 × 512	526
			256 × 256	1020
			256 × 8	11 500
			256 × 4	13 800
			2048 × 1152	94.2
			1024 × 576	119

Note

- The frame rate value is valid 3 digits and rounded down to 4th digit.

Note

- The calculation formula and the frame rate value of Start trigger mode (External trigger mode) are same as Free running mode. About this mode, refer to 11-1-6-3 "Start trigger mode".

Note

- Ultra quiet mode is used for the Photon number resolving mode.

3. 8 bit digital output

Operation modes	Binning	Calculation formula	Hn × Vn	Max frame rate (fps)
Free running mode	1×1	If (Exp2 < 13 889): 1 / (Vn2 + Vn5) / 1H Others: 1 / Exp2 / 1H	4096 × 2304	35.3
			2048 × 2048	79.5
			1024 × 1024	268
			512 × 512	532
			256 × 256	1040
			256 × 8	15 400
			256 × 4	19 800
2×2	2048 × 1152	120		
4×4	1024 × 576	120		
External trigger mode (Edge trigger)	1 × 1	If (Vn6 = Vn4) 1 / (Vn6 + 1) / 1H Others: 1 / (Vn6 + 2) / 1H	4096 × 2304	35.3
			2048 × 2048	79.5
			1024 × 1024	268
			512 × 512	530
			256 × 256	1030
			256 × 8	13 800
			256 × 4	17 300
2 × 2	2048 × 1152	119		
4 × 4	1024 × 576	119		
External trigger mode (Level trigger / Global reset edge trigger / Global reset level trigger)	1×1	If (Vn2 + Exp2 + 2 < V4): 1 / (Vn4 + 1) / 1H Others: 1 / (Vn2 + Exp2 + 3) / 1H	4096 × 2304	35.3
			2048 × 2048	79.5
			1024 × 1024	266
			512 × 512	524
			256 × 256	1013
			256 × 8	10 600
			256 × 4	12 600
2×2	2048 × 1152	119		
4×4	1024 × 576	119		
External trigger mode (Synchronous readout trigger)	1×1	1 / (Vn7 + 1) / 1H	4096 × 2304	35.3
			2048 × 2048	79.5
			1024 × 1024	267
			512 × 512	526
			256 × 256	1020
			256 × 8	11 500
			256 × 4	13 800
2×2	2048 × 1152	119		
4×4	1024 × 576	119		

Note

- The frame rate value is valid 3 digits and rounded down to 4th digit.

Note

- The calculation formula and the frame rate value of Start trigger mode (External trigger mode) are same as Free running mode. About this mode, refer to 11-1-6-3 "Start trigger mode".

Note

- Ultra quiet mode is used for the Photon number resolving mode.

(3) Ultra quiet scan: CoaXPress

Exp1 = 33.9 μ s to 1800 s (input in units of seconds)

1H = 33.9 μ s

Exp2 = ROUNDUP (Exp1 / 1H) * Round up to integer

Vn1 = Number of vertical lines

Vn2 = (Vn1 / 2) + 5

Conditions		Vn3
Exp2 < 29 456	Exp2 < Vn2	0
	Exp2 \geq Vn2	Exp2 - Vn2 + 1
Exp2 \geq 29 456		0

Vn4 = MAX (Vn2, Exp2)

Vn5 = MAX (Vn2 + 2, Exp2)

Operation modes	Calculation formula	Horizontal	Vertical	Max frame rate (fps)
Free running mode	If (Exp2 < 29 456): $1 / (Vn2 + Vn3) / 1H$ Others: $1 / Exp2 / 1H$	4096	2304	25.4
			2048	28.6
			1024	56.9
			512	112
			256	221
			8	3270
			4	4200
External trigger mode (Edge trigger)	If (Vn4 = Vn2) $1 / (Vn4 + 1) / 1H$ Others: $1 / (Vn4 + 2) / 1H$	4096	2304	25.4
			2048	28.5
			1024	56.8
			512	112
			256	219
			8	2940
External trigger mode (Level trigger / Global reset edge trigger / Global reset level trigger)	$1 / (Vn2 + Exp2 + 3) / 1H$	4096	2304	25.3
			2048	28.5
			1024	56.5
			512	111
			256	215
			8	2260
External trigger mode (Synchronous readout trigger)	$1 / (Vn5 + 1) / 1H$	4096	2304	25.3
			2048	28.5
			1024	56.6
			512	111
			256	216
			8	2450
		4096	4	2940

Note

- The frame rate value is valid 3 digits and rounded down to 4th digit.

Note

- The calculation formula and the frame rate value of Start trigger mode (External trigger mode) are same as Free running mode.

Note

- The calculation formula and the frame rate value do not depend on the bit depth of digital output.

Note

- Ultra quiet mode is used for the Photon number resolving mode.

(4) Ultra quiet scan: USB

Exp1 = 33.9 μ s to 1800 s (input in units of seconds)
 1H = 33.9 μ s
 Exp2 = ROUNDUP (Exp1 / 1H) * Round up to integer
 Hn1 = Number of horizontal lines (Binning OFF)
 BN = Binning setting

Output bit depth	BW = Interface band width
16 bit	167 473 152
12 bit	223 297 536
8 bit	334 946 304

Vn1 = Number of vertical line (Binning OFF)
 Vn2 = $(Vn1 + 6) / 2 + 2$
 Vn3 = ROUNDUP (Hn1 * (Vn1 + 6) / BW / BN² / 1H)
 Vn4 = MAX (Vn2, Vn3)

Conditions		Vn5
Exp2 < 29 456	Exp2 < Vn2	Vn4
	Exp2 \geq Vn2	Exp2 + 1
Exp2 \geq 29 456		0

Vn6 = MAX (Vn4, Exp2)
 Vn7 = MAX (Vn2 + 2, Vn4, Exp2)

1. 16 bit digital output

Operation modes	Binning	Calculation formula	Hn \times Vn	Max frame rate (fps)
Free running mode	1 \times 1	If (Exp2 < 29 456): 1 / Vn5 / 1H Others: 1 / Exp2 / 1H	4096 \times 2304	17.6
			2048 \times 2048	28.6
			1024 \times 1024	56.9
			512 \times 512	112
			256 \times 256	221
			256 \times 8	3270
			256 \times 4	4200
External trigger mode (Edge trigger)	1 \times 1	If (Vn6 = Vn4) 1 / (Vn6 + 1) / 1H Others: 1 / (Vn6 + 2) / 1H	4096 \times 2304	17.6
			2048 \times 2048	28.5
			1024 \times 1024	56.8
			512 \times 512	112
			256 \times 256	219
			256 \times 8	2940
			256 \times 4	3680
External trigger mode (Level trigger / Global reset edge trigger / Global reset level trigger)	1 \times 1	If (Vn2 + Exp2 + 2 < V4): 1 / (Vn4 + 1) / 1H Others: 1 / (Vn2 + Exp2 + 3) / 1H	4096 \times 2304	17.6
			2048 \times 2048	28.5
			1024 \times 1024	56.5
			512 \times 512	111
			256 \times 256	215
			256 \times 8	2260
			256 \times 4	2670
	2 \times 2		2048 \times 1152	25.3
	4 \times 4		1024 \times 576	25.3

Operation modes	Binning	Calculation formula	Hn × Vn	Max frame rate (fps)
External trigger mode (Synchronous readout trigger)	1×1	$1 / (Vn7 + 1) / 1H$	4096 × 2304	17.6
			2048 × 2048	28.5
			1024 × 1024	56.6
			512 × 512	111
			256 × 256	216
			256 × 8	2450
			256 × 4	2940
	2×2		2048 × 1152	25.3
	4×4		1024 × 576	25.3

Note

- The frame rate value is valid 3 digits and rounded down to 4th digit.

Note

- The calculation formula and the frame rate value of Start trigger mode (External trigger mode) are same as Free running mode.

Note

- Ultra quiet mode is used for the Photon number resolving mode.

2. 12 bit digital output

Operation modes	Binning	Calculation formula	Hn × Vn	Max frame rate (fps)
Free running mode	1×1	If (Exp2 < 29 456): 1 / (Vn2 + Vn5) / 1H Others: 1 / Exp2 / 1H	4096 × 2304	23.5
			2048 × 2048	28.6
			1024 × 1024	56.9
			512 × 512	112
			256 × 256	221
			256 × 8	3270
			256 × 4	4200
2×2	2048 × 1152	25.4		
4×4	1024 × 576	25.4		
External trigger mode (Edge trigger)	1 × 1	If (Vn6 = Vn4) 1 / (Vn6 + 1) / 1H Others: 1 / (Vn6 + 2) / 1H	4096 × 2304	23.5
			2048 × 2048	28.5
			1024 × 1024	56.8
			512 × 512	112
			256 × 256	219
			256 × 8	2940
			256 × 4	3680
2 × 2	2048 × 1152	25.4		
4 × 4	1024 × 576	25.4		
External trigger mode (Level trigger / Global reset edge trigger / Global reset level trigger)	1×1	If (Vn2 + Exp2 + 2 < V4): 1 / (Vn4 + 1) / 1H Others: 1 / (Vn2 + Exp2 + 3) / 1H	4096 × 2304	23.5
			2048 × 2048	28.5
			1024 × 1024	56.5
			512 × 512	111
			256 × 256	215
			256 × 8	2260
			256 × 4	2670
2×2	2048 × 1152	25.3		
4×4	1024 × 576	25.3		
External trigger mode (Synchronous readout trigger)	1×1	1 / (Vn7 + 1) / 1H	4096 × 2304	23.5
			2048 × 2048	28.5
			1024 × 1024	56.6
			512 × 512	111
			256 × 256	216
			256 × 8	2450
			256 × 4	2940
2 × 2	2048 × 1152	25.3		
4 × 4	1024 × 576	25.3		

- Note** • The frame rate value is valid 3 digits and rounded down to 4th digit.
- Note** • The calculation formula and the frame rate value of Start trigger mode (External trigger mode) are same as Free running mode.
- Note** • Ultra quiet mode is used for the Photon number resolving mode.

3. 8 bit digital output

Operation modes	Binning	Calculation formula	Hn × Vn	Max frame rate (fps)
Free running mode	1×1	If (Exp2 < 29 456): 1 / (Vn2 + Vn5) / 1H Others: 1 / Exp2 / 1H	4096 × 2304	25.4
			2048 × 2048	28.6
			1024 × 1024	56.9
			512 × 512	112
			256 × 256	221
			256 × 8	3270
			256 × 4	4200
			2048 × 1152	25.4
			1024 × 576	25.4
External trigger mode (Edge trigger)	1 × 1	If (Vn6 = Vn4) 1 / (Vn6 + 1) / 1H Others: 1 / (Vn6 + 2) / 1H	4096 × 2304	23.5
			2048 × 2048	28.5
			1024 × 1024	56.8
			512 × 512	112
			256 × 256	219
			256 × 8	2940
			256 × 4	3680
			2048 × 1152	25.4
			1024 × 576	25.4
External trigger mode (Edge trigger / Level trigger / Global reset edge trigger / Global reset level trigger)	1×1	If (Vn2 + Exp2 + 2 < V4): 1 / (Vn4 + 1) / 1H Others: 1 / (Vn2 + Exp2 + 3) / 1H	4096 × 2304	25.4
			2048 × 2048	28.5
			1024 × 1024	56.5
			512 × 512	111
			256 × 256	215
			256 × 8	2260
			256 × 4	2670
			2048 × 1152	25.3
			1024 × 576	25.3
External trigger mode (Synchronous readout trigger)	1×1	1 / (Vn6 + 1) / 1H	4096 × 2304	25.3
			2048 × 2048	28.5
			1024 × 1024	56.6
			512 × 512	111
			256 × 256	216
			256 × 8	2450
			256 × 4	2940
			2048 × 1152	25.3
			1024 × 576	25.3

Note

- The frame rate value is valid 3 digits and rounded down to 4th digit.

Note

- The calculation formula and the frame rate value of Start trigger mode (External trigger mode) are same as Free running mode.

Note

- Ultra quiet mode is used for the Photon number resolving mode.

11-1-5 CONFIGURING EXPOSURE TIME

The exposure time setting can be done by the units of seconds.
 The actual exposure time setting is defined by the following formula, and the camera automatically calculates a longer and closest value from the specified exposure time setting.

(1) Standard scan

Exp1 = 7.2 μ s to 1800 s (input in units of seconds)
 1H = 7.2 μ s
 Exp2 = ROUNDUP (Exp1 / 1H) * Round up to integer

Calculation formula	$\text{Exp2} \times 1\text{H}$
---------------------	--------------------------------

(2) Ultra quiet scan

Exp1 = 33.9 μ s to 1800 s (input in units of seconds)
 1H = 33.9 μ s
 Exp2 = ROUNDUP (Exp1 / 1H) * Round up to integer

Calculation formula	$\text{Exp2} \times 1\text{H}$
---------------------	--------------------------------

Available setting range of the exposure time is the following.

Scan speed	Available setting range of the exposure time
Standard scan	7.2 μ s to 1800 s (7.2 μ s step)
Ultra quiet scan	33.9 μ s to 1800 s (33.9 μ s step)

Note

- Ultra quiet mode is used for the Photon number resolving mode.

11-1-6 CAMERA OPERATION MODES

11-1-6-1 Free running mode

The camera has Free running mode which the exposure and readout timing can be set and controlled by an internal microprocessor. Free running mode has normal readout mode (in which the exposure time is longer than the 1 frame readout time) and electrical shutter mode (in which the exposure time is shorter than the 1 frame readout time). These readout modes are automatically switched depending on the exposure time setting.

Note

- Contact a Hamamatsu subsidiary or your local distributor for the detail of the timing information.

(1) Normal readout

The normal readout mode is suitable for observation, monitoring, field of view and focus adjustment, and animation because it can operate the fastest frame rate with full resolution. In case of standard scan and 16 bit digital output, maximum 120 fps with CoaXPress and 17.6 fps with USB can be achieved respectively.

In addition, the exposure time can be extended to collect more signals and increase the signal to noise ratio if the object is dark. In the normal readout mode, the exposure time is the same or longer than the 1 frame readout time. In this mode, the frame rate depends on the exposure time, and it becomes $\text{frame rate} = 1/\text{exposure time}$. The maximum exposure time is 1800 s.

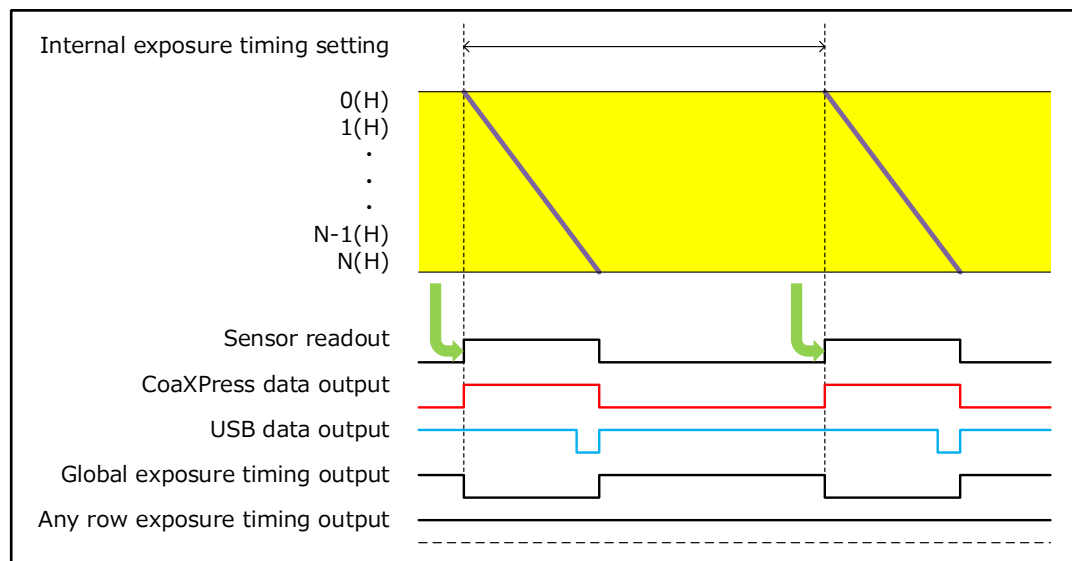

Figure 11-2

(2) Electrical shutter

The electrical shutter mode is used to get a proper signal level when signal overflow happens due to too much input photons in normal readout mode. In this mode, the fastest frame rate is 120 fps (Standard scan via CoaXPress), 17.6 fps (Standard scan via USB) or 25.4 fps (Ultra quiet scan via CoaXPress), 17.6 fps (Ultra quiet scan via USB) at full resolution even when the exposure time is short.

CoaXPress:

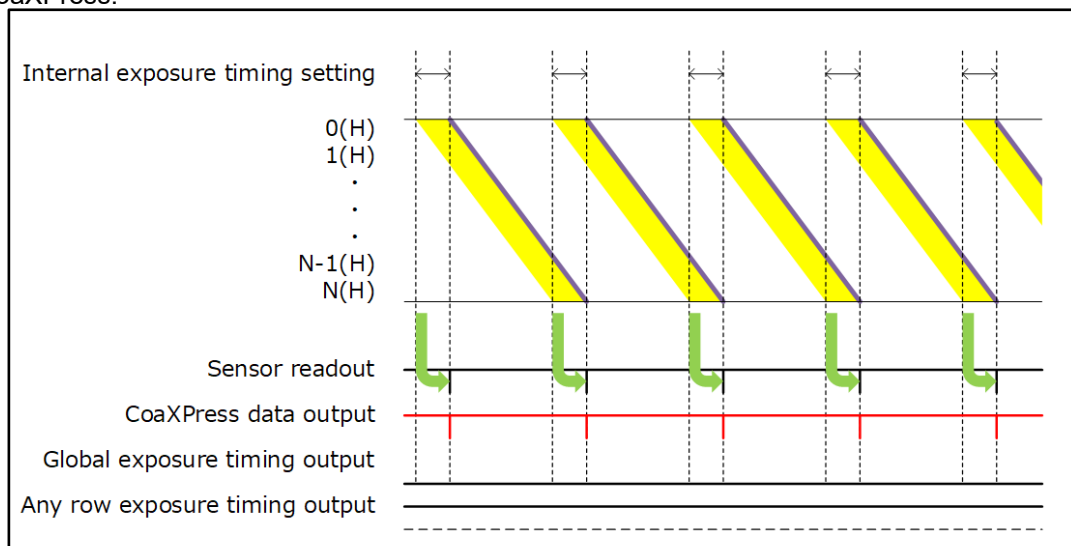

Figure 11-3

USB:

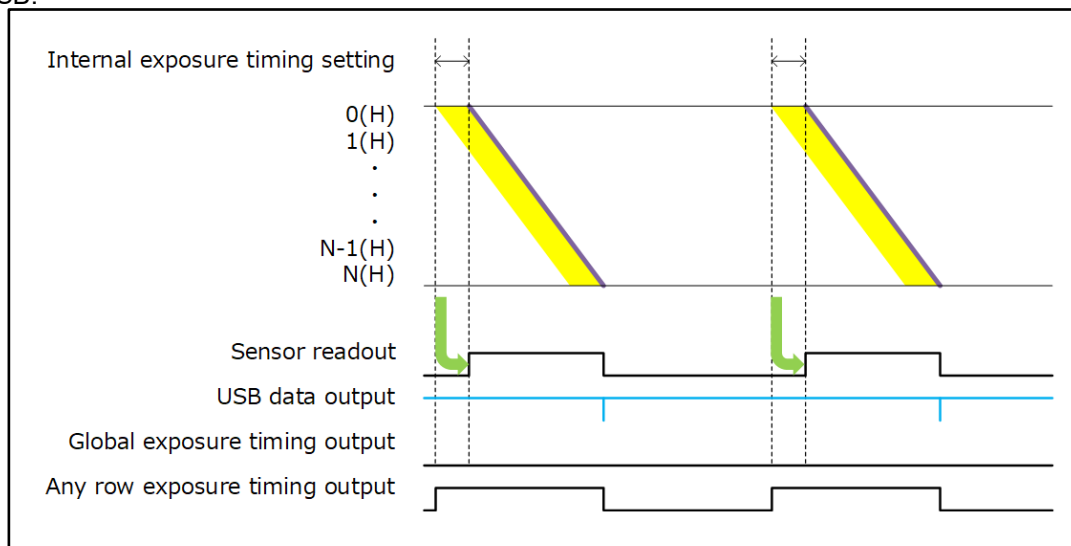

Figure 11-4

11-1-6-2 External trigger mode

The camera has various external trigger functions to synchronize the camera with the external equipment. In External trigger mode, the external equipment becomes a master and the camera becomes a slave.

Note

- Contact a Hamamatsu subsidiary or your local distributor for the detail of the timing information.

(1) Edge trigger mode

The Edge trigger mode is used so that the exposure starts according to an external signal. Exposure time can be set. In this mode, the exposures of the first and second lines begin at the edge (rising / falling) timing of the input trigger signal into the camera. (0 and 1 (H) in the following figure) The exposures of the third and fourth lines begin after the readout time of two lines (3 and 4 (H)), and the following exposures begin for every two lines.

(1)-1 When the exposure time setting is longer than 1V.

The period the camera can accept the external trigger is after the rising edge of sensor readout. During that period, the trigger ready output is enabled. (1V is the readout time of one frame.) (Refer to 11-1-7(4) "Trigger ready output" for the details.)

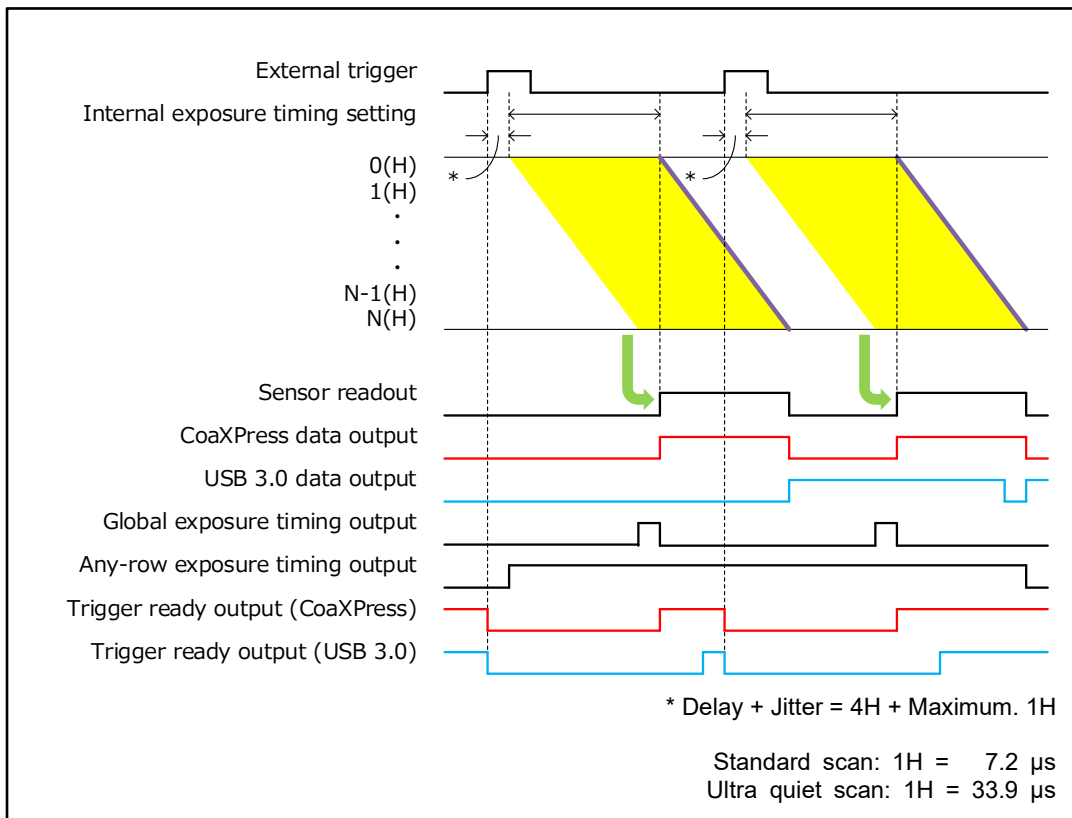

Figure 11-5 (Ex. rising edge)

(1)-2 When the exposure time setting is less than 1V.

The period the camera can accept the external trigger is after the rising edge of sensor readout. During that period, the trigger ready output is enabled.

(1V is the readout time of one frame.)

(Refer to 11-1-7(4) "Trigger ready output" for the details.)

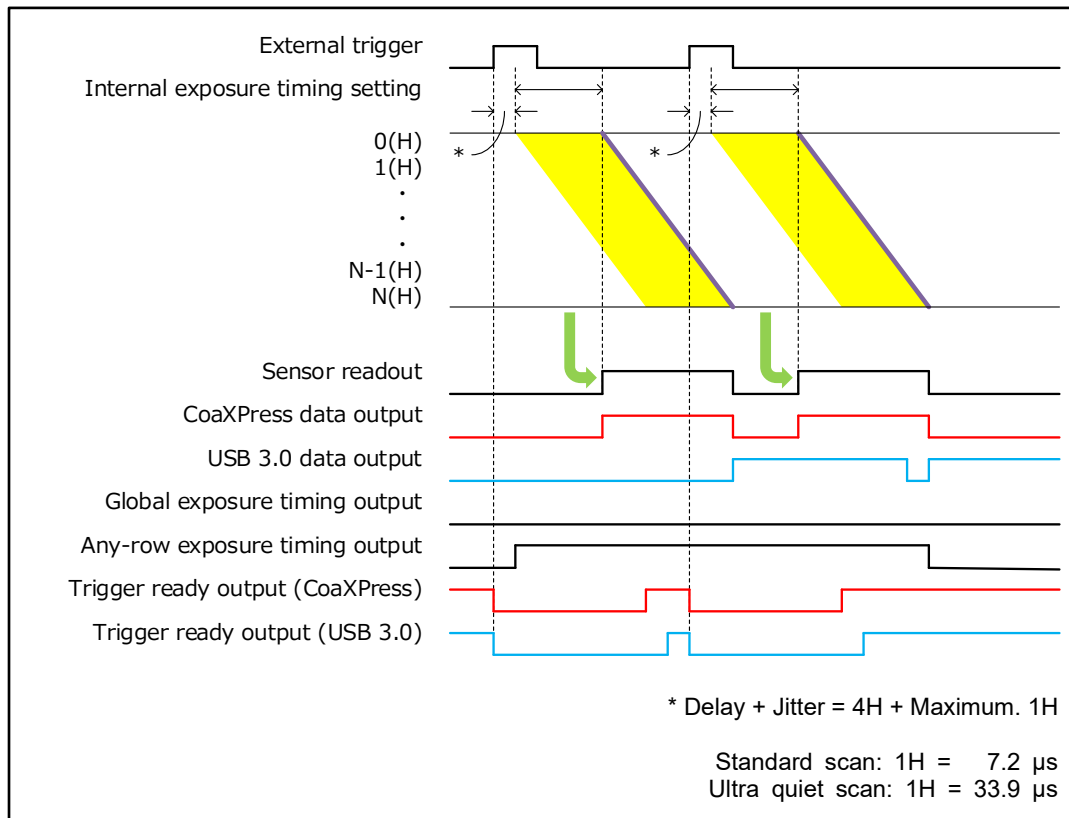

Figure 11-6 (Ex. rising edge)

(2) Global reset Edge trigger mode

Global reset function enables to reset the electric charge of all pixels at the same time. Then all pixels can start exposure at the same time.

With this Global reset Edge trigger mode, the exposure of all pixels begins on the edge (rising / falling) timing of the input trigger signal into the camera.

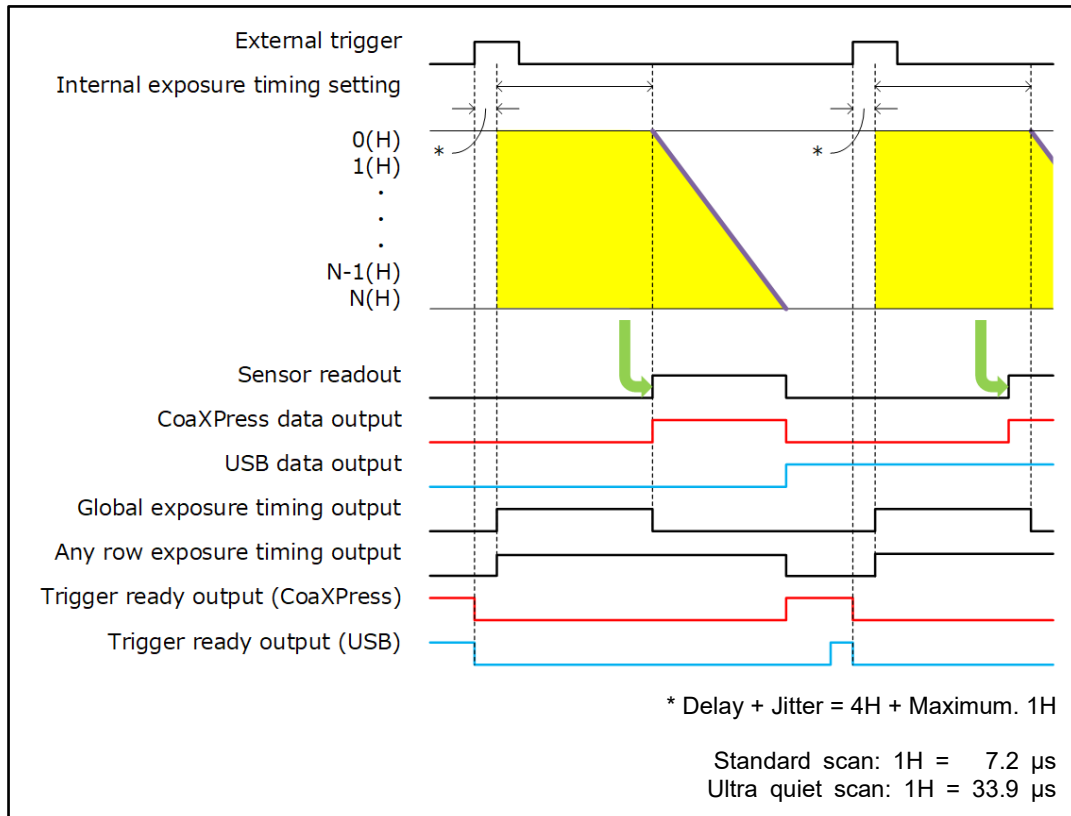

Figure 11-7 (Ex. rising edge)

(3) Level trigger mode

The Level trigger mode is used to control both exposure start timing and exposure time length by inputting external trigger pulses. In this mode, the camera starts exposure at the start of high or low period of the input trigger pulse and stops exposure at the end of high or low period of the input trigger pulse. The example below is for the trigger level High. The exposure of the first- and second- lines begin when the trigger signal becomes High, and the exposure of the third- and fourth- lines begin after the readout time of first- and second-lines pass. Each exposure begins one by one for every two lines. The exposure of the first- and second- lines are finished when the trigger signal becomes low, and signal readout is begun. The exposure time of each line is defined by the time that the input trigger is high.

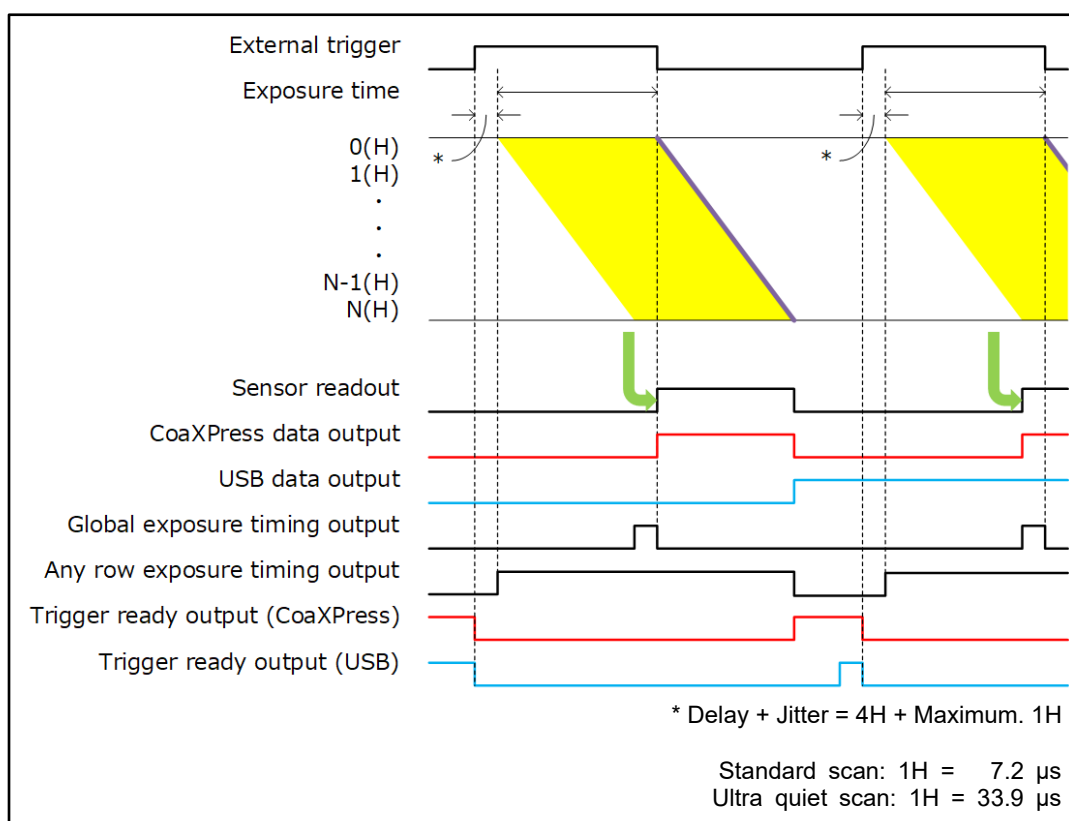

Figure 11-8 (Ex. level High)

(4) Global reset Level trigger mode

Global reset function enables to reset the electric charge of all pixels at the same time. Then all pixels can start exposure at the same time.

The example below is for the trigger level High. With this Global reset Level trigger mode, the exposure of all pixels begins when the trigger signal becomes High.

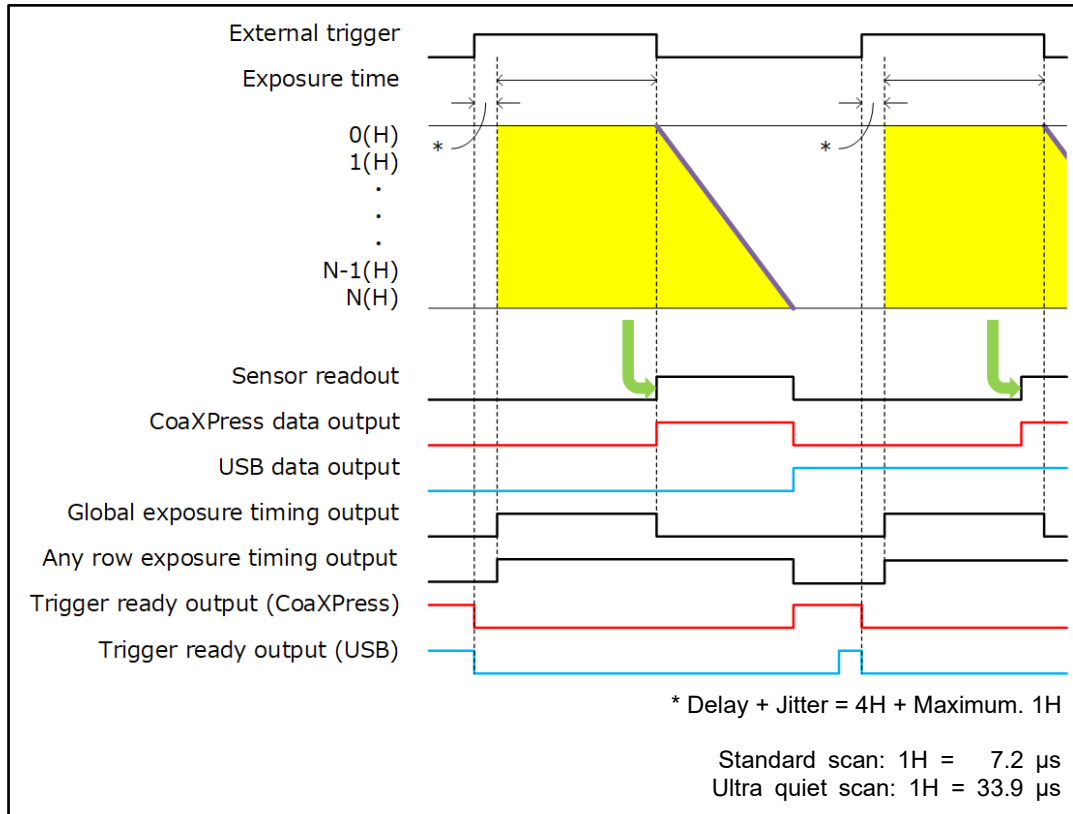

Figure 11-9 (Ex. level High)

(5) Synchronous readout trigger mode

The Synchronous readout trigger mode is used for continuous imaging when it is necessary to control the exposure start timing of each frame from an external source. It is useful for confocal microscopy. For example, when the camera is used with a spinning disk confocal microscope and the camera exposure time is synchronized to the spinning disk's rotation speed, it is possible to eliminate uneven illumination (called banding noise) caused by variation of the spinning disk rotation speed. Also, it is useful for securing as long exposure time as possible while controlling the exposure start timings by external trigger signals.

Normal operation (when the Trigger Time is set as 1.);

The Synchronous readout trigger mode is used for continuous imaging when it is necessary to control the exposure start timing of each frame from an outside source and also when it is necessary to secure as long exposure time as possible. In the Synchronous readout trigger mode, the camera ends each exposure, starts the readout and also, at the same time, starts the next exposure at the edge of the input trigger signal (rising / falling edge). That is, the interval between the same edges of the input trigger becomes the exposure time.

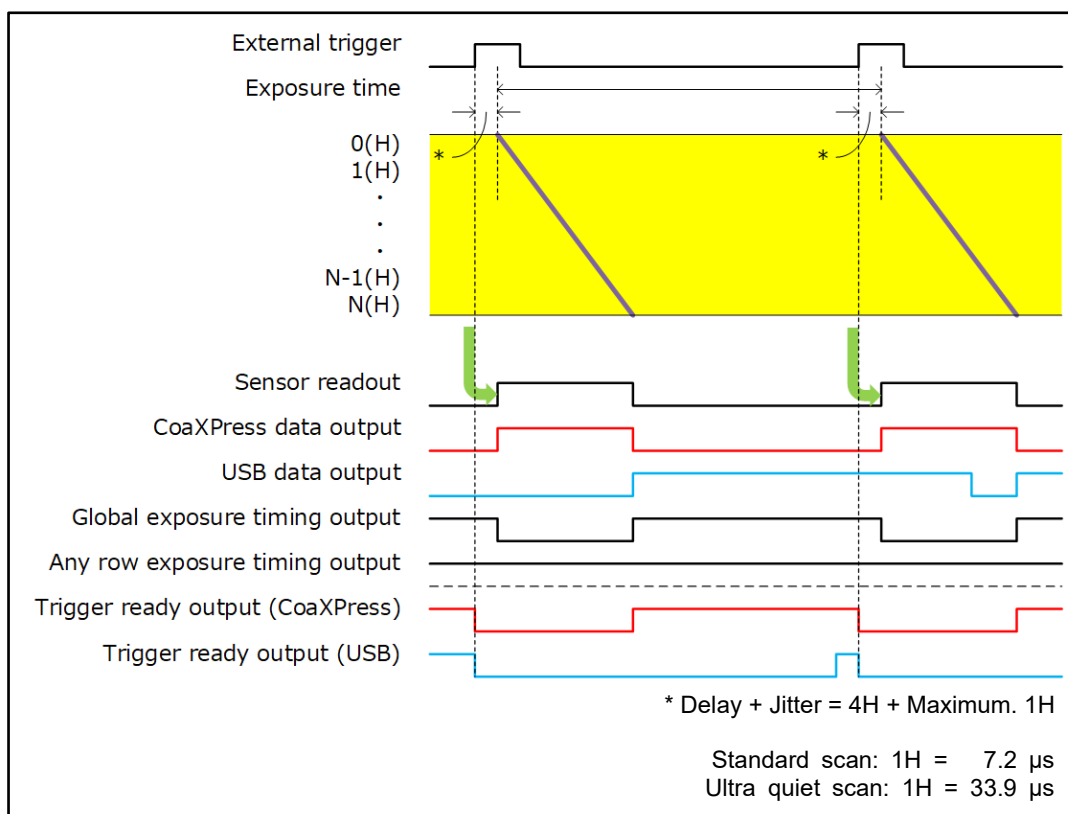

Figure 11-10 (Ex. rising edge)

Trigger Times;

Also in the Synchronous readout trigger mode, synchronous readout can be controlled by specifying, the number of timing pulses to determine the exposure time. The input trigger is valid only during the trigger ready is enabled.

The following figure shows the exposure timing when the Trigger Times is set as 4.

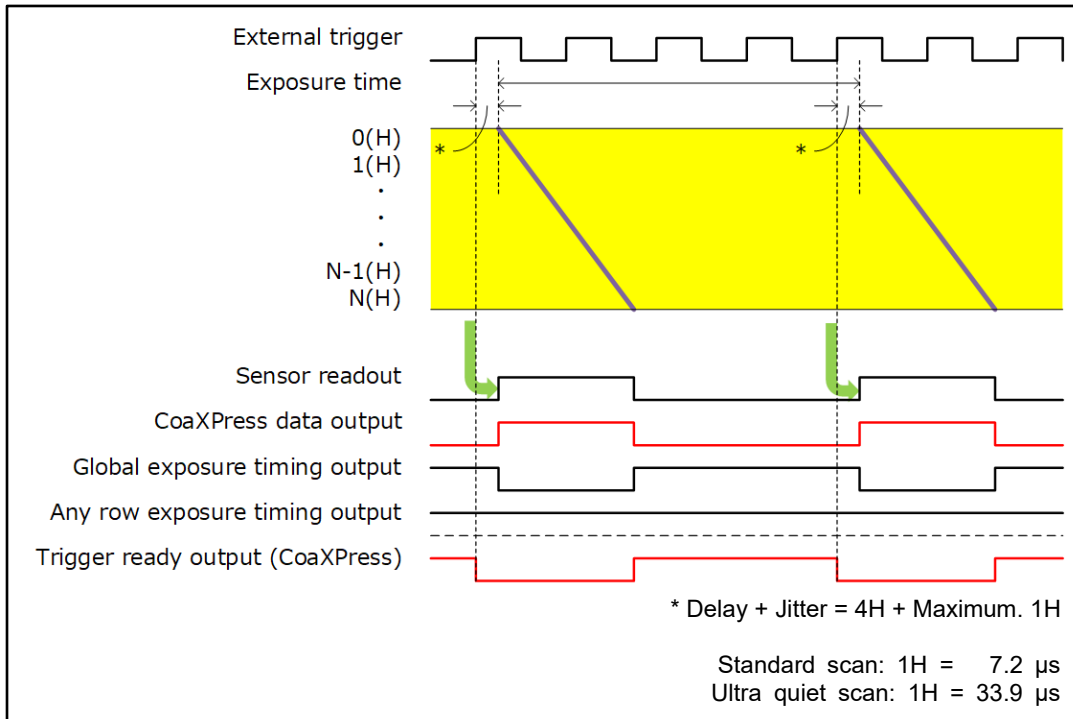

Figure 11-11 (Trigger Times)

11-1-6-3 Start trigger mode

Start trigger mode is to start operating the camera by a trigger input for a continuous imaging. It is useful to secure the frame rate as fast as possible when continuous image acquisition and not to sacrifice the exposure time. For example, when it is necessary to measure the phenomenon after stimulation, it is possible to start continuous image acquisition at the stimulation timing.

Start trigger mode is to start operating the camera by a trigger input for continuous imaging, and it works at the highest frame rate because it is operated in internal trigger mode. In Start trigger mode, the camera starts exposure and switches to internal trigger mode by the edge of an external trigger signal (rising / falling edge).

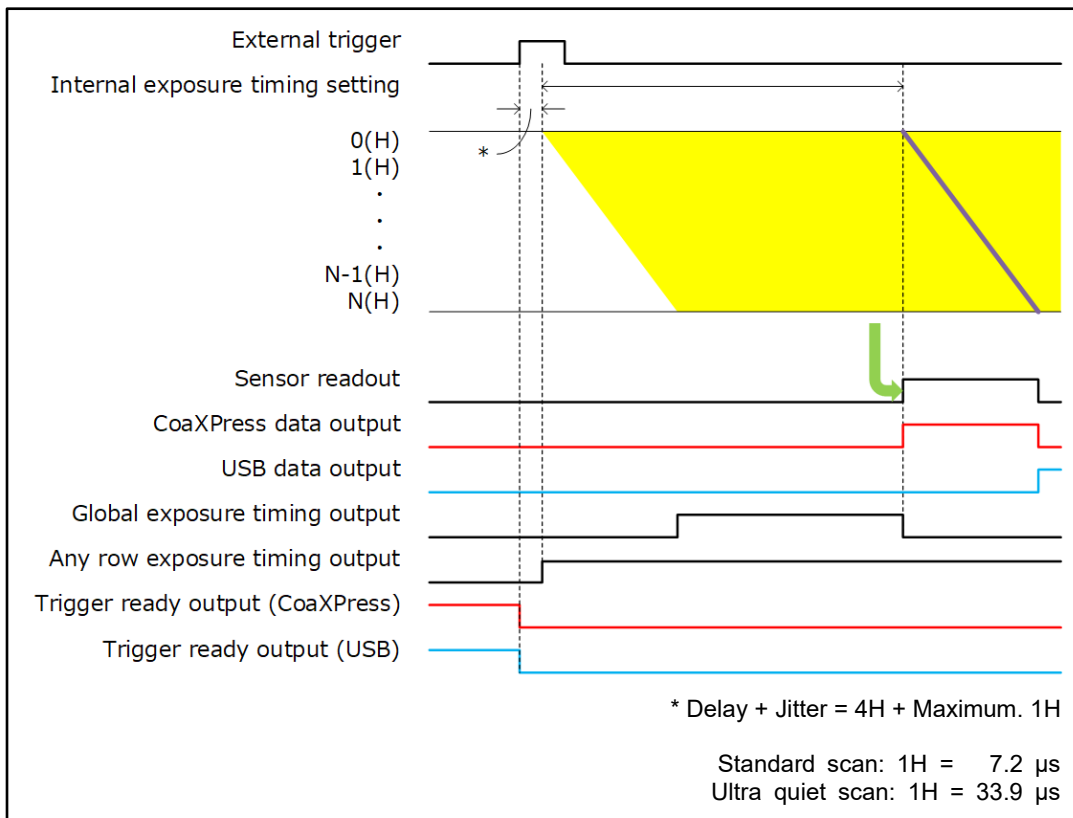

Figure 11-12 (Ex. rising edge)

11-1-6-4 External trigger delay function

In most cases when a delay between the laser pulse emission and the exposure start is needed, a delay unit is set between the laser and camera to control trigger timing. In each external trigger mode of the camera, the delay can be set to the trigger signal input to the camera by command. With this setting, a range of trigger can be arranged without a delay unit. The range for delay time is 0 μs to 10 s (1 μs steps).

11-1-7 TIMING OUTPUT

The camera provides a range of trigger output signals to synchronize with an external instrument and the camera becomes the master and the external instrument becomes the slave.

There are four different trigger output functions as follows.

- Global exposure timing output
- Any low exposure timing output
- Programmable timing output
- Trigger ready output

Also, it can output continuous High output (High output fixed) or continuous Low output (Low output fixed). They are output from trigger output connector.

(1) Global exposure timing output

It shows the global exposure timing where all lines expose at the same time. There is a case that one event is divided into two frames because the timing of the exposure in each line is different for the rolling shutter. However, by using the Global exposure timing output the global exposure becomes possible for the phenomenon that happens for this period. Global exposure timing output shows the period where all lines expose at the same time.

Note

- There is no output signal when the exposure time is less than the frame rate.

(2) Any row exposure timing output

Global exposure timing output shows the global exposure timing where all lines expose at the same time. While the any row exposure timing shows when any of the rows.

(3) Programmable timing output

By using the programmable timing output, synchronizing external devices is simple. A system that needs simple timing signal does not require a delay unit or pulse generator. It is possible to program and output a pulse that has an optional pulse width and an optional delay time to Read End (the end of readout timing), Vsync or Input trigger signal. The setting range for delay time is 0 μ s to 10 s, and the setting range for pulse width is 1 μ s to 10 s.

The relation between the parameter which can be set with each reference signal, and an output signal becomes below.

Reference signal	Output signal
Read End	The signal with the preset pulse width is output after the preset delay from the end of the sensor readout.
Vsync	The signal with the preset pulse width is output after the preset delay from the start of the sensor readout.
Input trigger signal	The signal with the preset pulse width is output after the preset delay from the input signal.

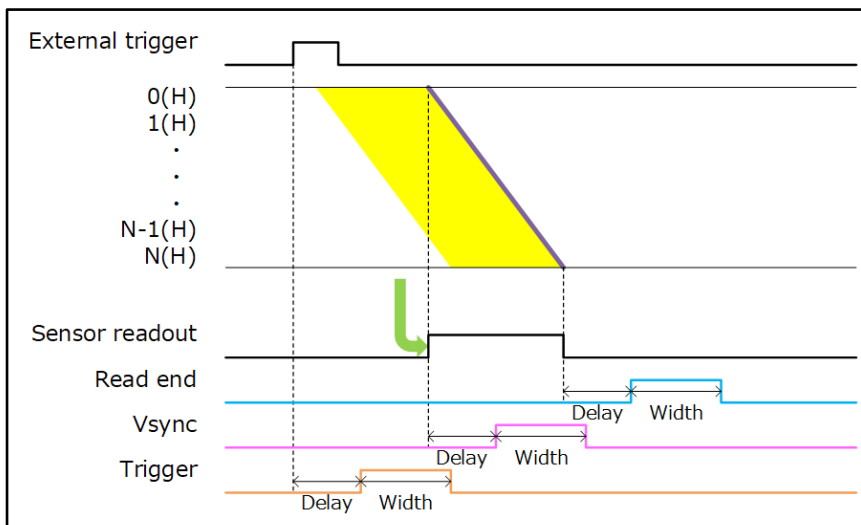

Figure 11-13 Programmable timing output

(4) Trigger ready output

The trigger ready output is useful to make the frame intervals as short as possible in external trigger mode. For example, when the camera is working in the Edge trigger mode, the next frame can start after the previous frame exposure is done. Thus, the camera cannot accept a trigger for the next frame during the exposure period. To reduce useless time to be as short as possible, it is necessary to know the period when the camera can accept a trigger for the next frame. The trigger ready output shows the trigger ready period when the camera can accept an external trigger in External trigger mode.

11-2 LIGHTSHEET READOUT MODE

Lightsheet Readout Mode is a unique feature of CMOS image sensor which provides improved control over the rolling shutter mechanism.

By finely synchronizing the camera readout with the illumination scan, scattered light is rejected allowing images of higher signal to noise ratios to be acquired.

The detail information of Lightsheet Readout Mode is published on our website.

Website <https://www.hamamatsu.com/jp/en/product/cameras/cmos-cameras/lightsheet-readout-mode.html>

11-2-1 READOUT DIRECTION

Lightsheet Readout Mode has 4 readout directions of Forward, Backward, Bidirectional and Reverse bidirectional. Forward mode readouts lines from top to bottom (Figure 11-14). Backward mode readouts lines from bottom to top (Figure 11-15). Bidirectional mode readouts lines from top to bottom at the first frame, and switches the readout direction in frame by frame (Figure 11-16). Reverse bidirectional mode readouts lines from bottom to top at the first frame, and switches the readout direction in frame by frame (Figure 11-17).

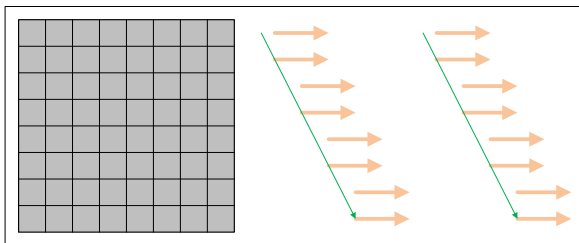

Figure 11-14 Forward mode (Top to Bottom)

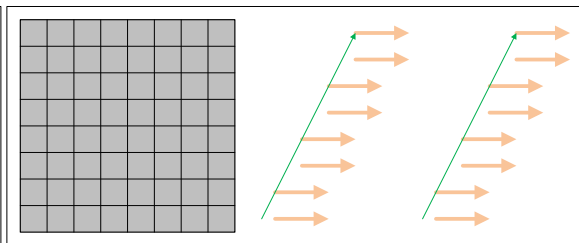

Figure 11-15 Backward mode (Bottom to Top)

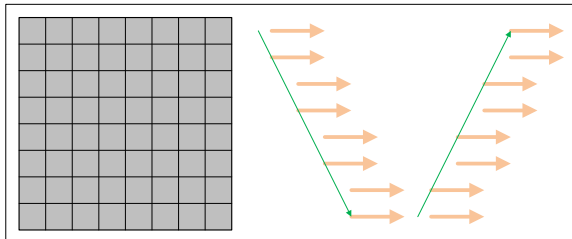

Figure 11-16 Bidirectional mode

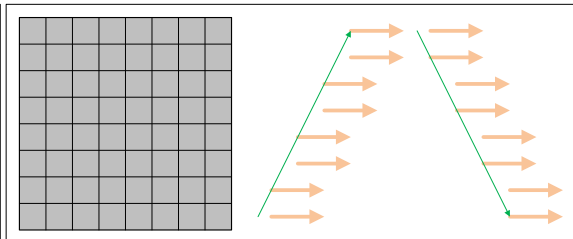

Figure 11-17 Reverse Bidirectional mode

11-2-2 ABOUT READOUT AT LIGHTSHEET READOUT MODE

(1) Readout methods

This mode can set Normal readout and Sub-array readout.

Binning readout mode is not supported at Lightsheet Readout Mode.

The size and the position of the sub-array readout can be configured according to the table below.

Size		Position	
Horizontal	Vertical	Horizontal	Vertical
1 pixels	4 lines	1 pixels	4 lines

Note

- Minimum settable step of the size and position on the table is in only the case that the camera is used with DCAM-API.

(2) Camera operation modes

This mode can use; Free running mode, Edge trigger mode (External trigger mode), and Start trigger mode.

11-2-3 FRAME RATE CALCULATION

(1) CoaXPress

Exp1 = 7.2 μ s to 273.7152 ms (input in units of seconds)

1H = 7.2 μ s to 237.6 μ s

Exp2 = ROUNDUP (Exp1 / 1H) * Round up to integer

Vn1 = Number of vertical lines

Vn2 = (Vn1 / 2) + 5

Operation modes	Calculation formula	Horizontal	Vertical	Max frame rate (fps)
Free running mode	$1 / (Vn2 + Exp2 + 2) / 1H$	4096	2304	119
			2048	134
			1024	267
			512	526
			256	1021
			8	11 574
External trigger mode (Edge trigger)	$1 / (Vn2 + Exp2 + 3) / 1H$	4096	2304	119
			2048	134
			1024	266
			512	524
			256	1013
			8	10 683
			4	12 626

Note

- The frame rate value is valid 3 digits and rounded down to 4th digit.

Note

- The calculation formula and the frame rate value of Start trigger mode (External trigger mode) are same as Free running mode.

Note

- The calculation formula and the frame rate value do not depend on the bit depth of digital output.

(2) USB

Exp1 = 7.2 μs to 273.7152 ms (input in units of seconds)

1H = 7.2 μs to 237.6 μs

Exp2 = ROUNDUP (Exp1 / 1H) * Round up to integer

Hn1 = Number of horizontal lines

Output bit depth	BW = Interface band width
16 bit	167 473 152
12 bit	223 297 536
8 bit	334 946 304

Vn1 = Number of vertical line

Vn2 = (Vn1 / 2) + 5

Vn3 = ROUNDUP (Hn1 * (Vn1 + 6) / BW / 1H)

1. 16 bit Digital output

Operation modes	Calculation formula	Hn × Vn	Max frame rate (fps)
Free running mode	If (Exp2 + Vn2 + 2 < Vn3): 1 / Vn3 / 1H Others: 1 / (Exp2 + Vn2 + 2) / 1H	4096 × 2304	17.6
		2048 × 2048	39.8
		1024 × 1024	158
		512 × 512	526
		256 × 256	1021
		256 × 8	11 574
		256 × 4	13 888
External trigger mode (Edge trigger)	If (Exp2 + Vn2 + 2 < Vn3): 1 / (Vn3 + 1) / 1H Others: 1 / (Exp2 + Vn2 + 3) / 1H	4096 × 2304	17.6
		2048 × 2048	39.7
		1024 × 1024	158
		512 × 512	524
		256 × 256	1013
		256 × 8	10 683
		256 × 4	12 626

2. 12 bit Digital output

Operation modes	Calculation formula	Hn × Vn	Max frame rate (fps)
Free running mode	If (Exp2 + Vn2 + 2 < Vn3): 1 / Vn3 / 1H Others: 1 / (Exp2 + Vn2 + 2) / 1H	4096 × 2304	23.5
		2048 × 2048	53.0
		1024 × 1024	211
		512 × 512	526
		256 × 256	1021
		256 × 8	11 574
		256 × 4	13 888
External trigger mode (Edge trigger)	If (Exp2 + Vn2 + 2 < Vn3): 1 / (Vn3 + 1) / 1H Others: 1 / (Exp2 + Vn2 + 3) / 1H	4096 × 2304	23.5
		2048 × 2048	53.0
		1024 × 1024	211
		512 × 512	524
		256 × 256	1013
		256 × 8	10 683
		256 × 4	12 626

3. 8 bit Digital output

Operation modes	Calculation formula	Hn × Vn	Max frame rate (fps)
Free running mode	If (Exp2 + Vn2 + 2 < Vn3): 1 / Vn3 / 1H Others: 1 / (Exp2 + Vn2 + 2) / 1H	4096 × 2304	35.3
		2048 × 2048	79.5
		1024 × 1024	267
		512 × 512	528
		256 × 256	1028
		256 × 8	12 626
		256 × 4	15 432
External trigger mode (Edge trigger)	If (Exp2 + Vn2 + 2 < Vn3): 1 / (Vn3 + 1) / 1H Others: 1 / (Exp2 + Vn2 + 3) / 1H	4096 × 2304	35.3
		2048 × 2048	79.5
		1024 × 1024	267
		512 × 512	526
		256 × 256	1021
		256 × 8	11 574
		256 × 4	13 888

Note

- The frame rate value is valid 3 digits and rounded down to 4th digit.

Note

- The calculation formula and the frame rate value of Start trigger mode (External trigger mode) are same as Free running mode.

11-2-4 READOUT TIME OF THE HORIZONTAL LINE

Readout time and exposure time can be varied with Lightsheet Readout Mode for synchronizing the camera readout with the illumination scan.

Vn = Number of vertical lines
1H = 7.2 μs to 237.6 μs

$$\text{Readout time} = (Vn / 2 + 5) \times 1H$$

Available setting range of the exposure time is the following.

Vn = Number of vertical line
1H = 7.2 μs to 237.6 μs

Setting range	1H to Vn / 2 × 1H
---------------	-------------------

11-2-5 TIMING DIAGRAM

(1) Free running mode

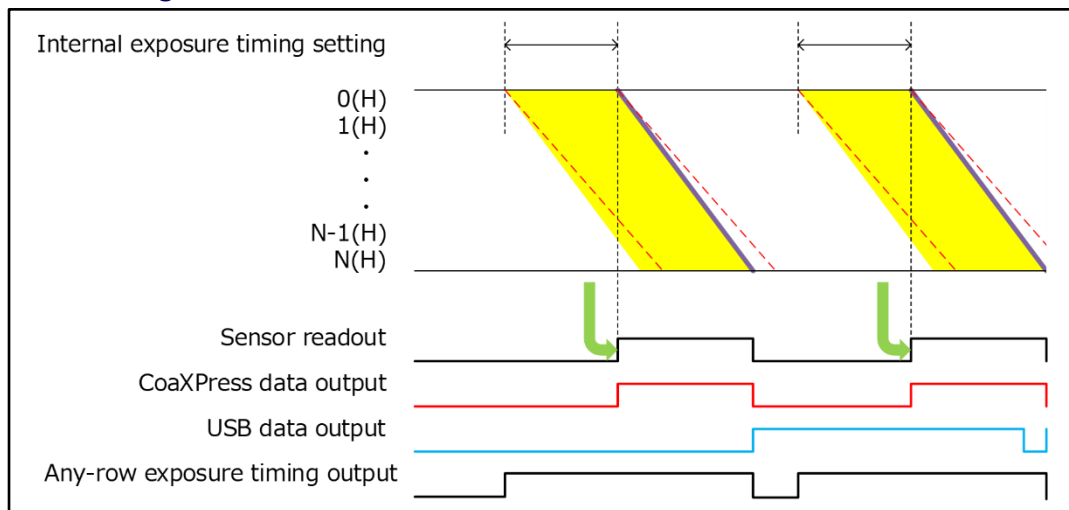

Figure 11-18 (Ex. Top to bottom readout)

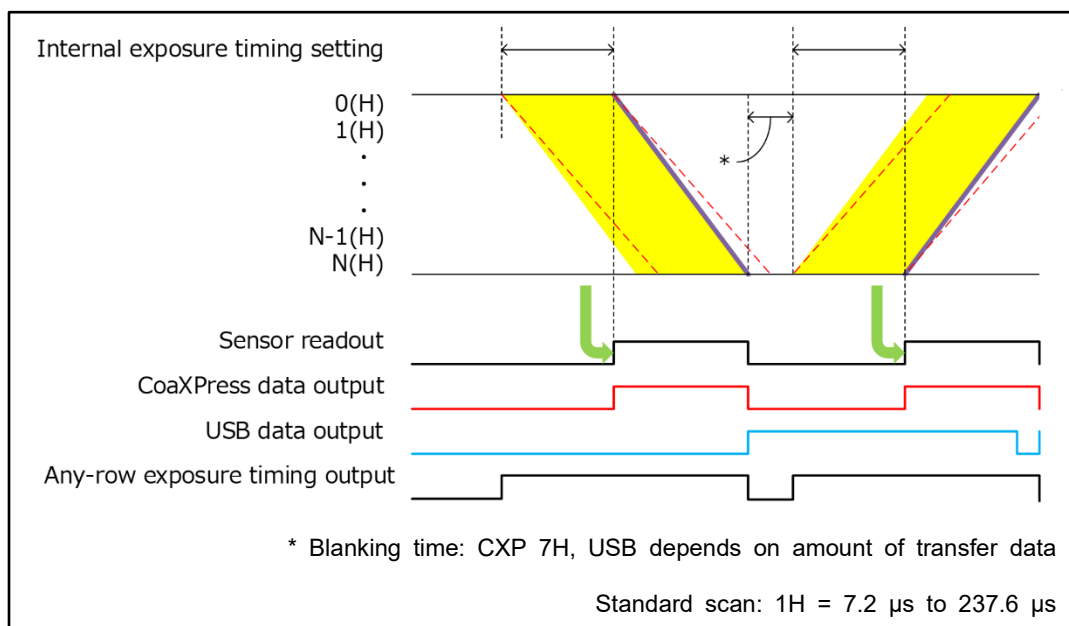

Figure 11-19 (Ex. Bidirectional readout)

(2) Edge trigger mode (External trigger mode)

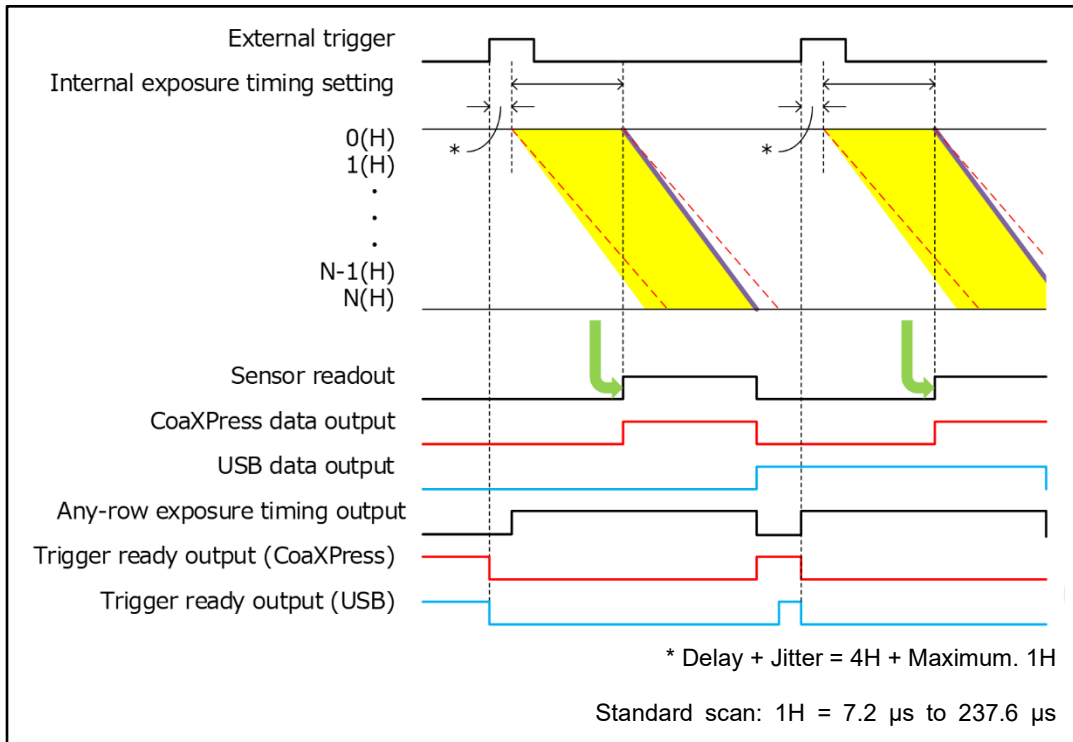

Figure 11-20 (Ex. rising edge, Top to bottom readout)

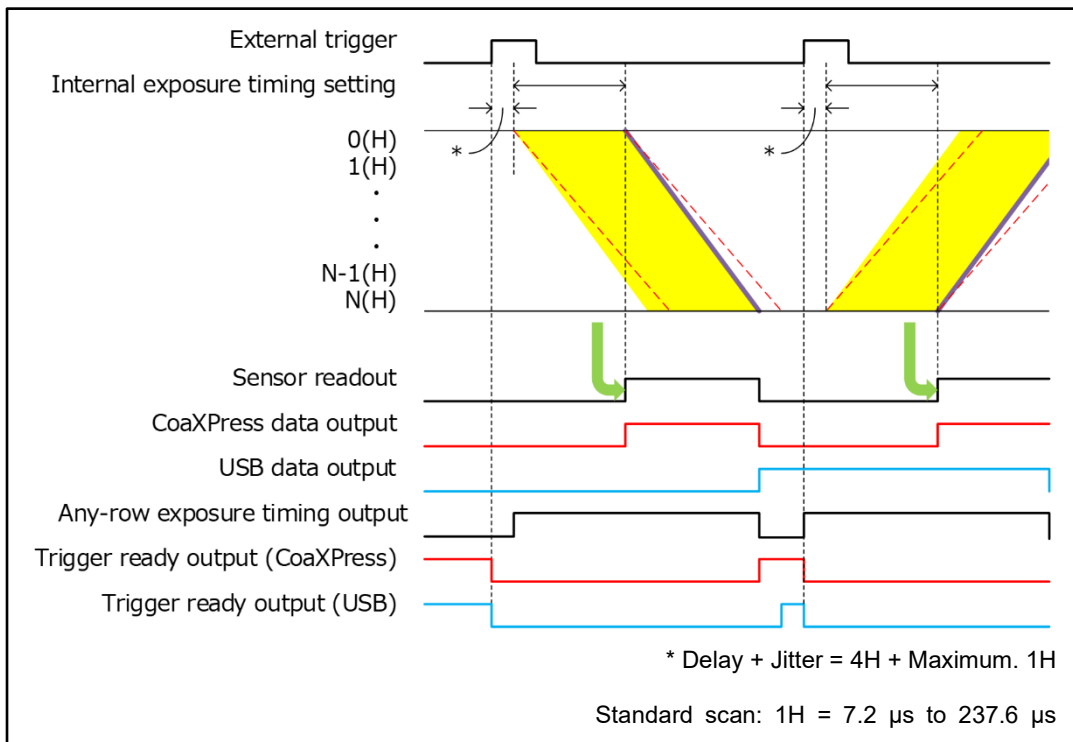

Figure 11-21 (Ex. rising edge, Top to bottom readout)

(3) Start trigger mode

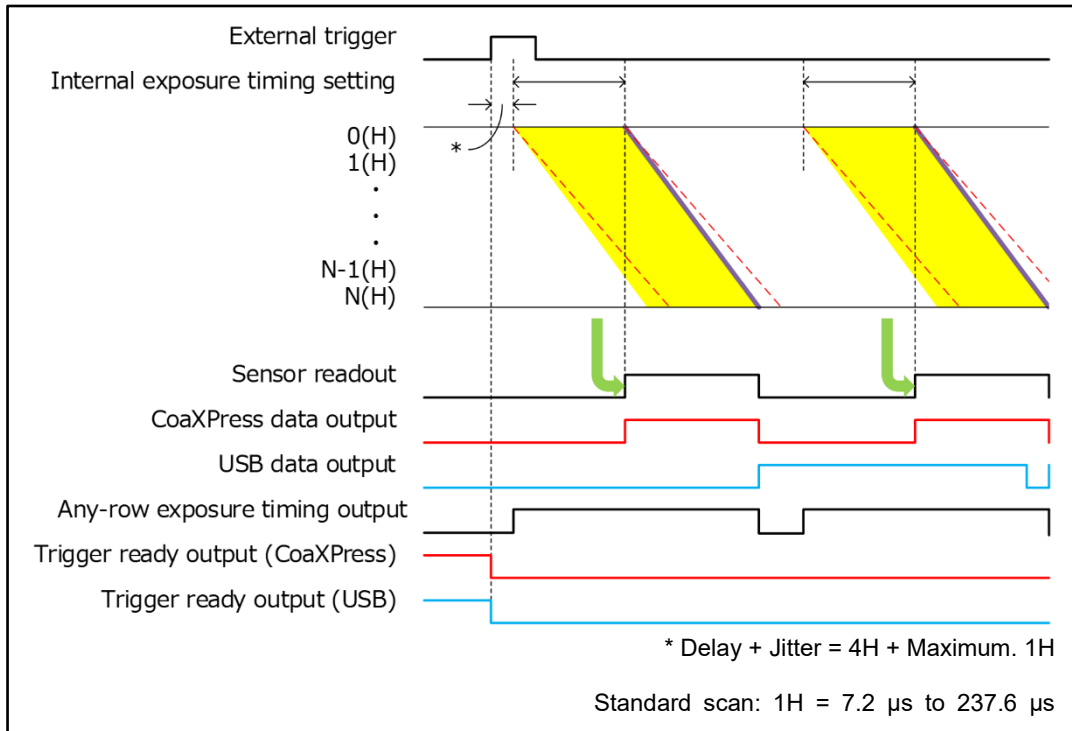

Figure 11-22 (Ex. rising edge, Top to bottom readout)

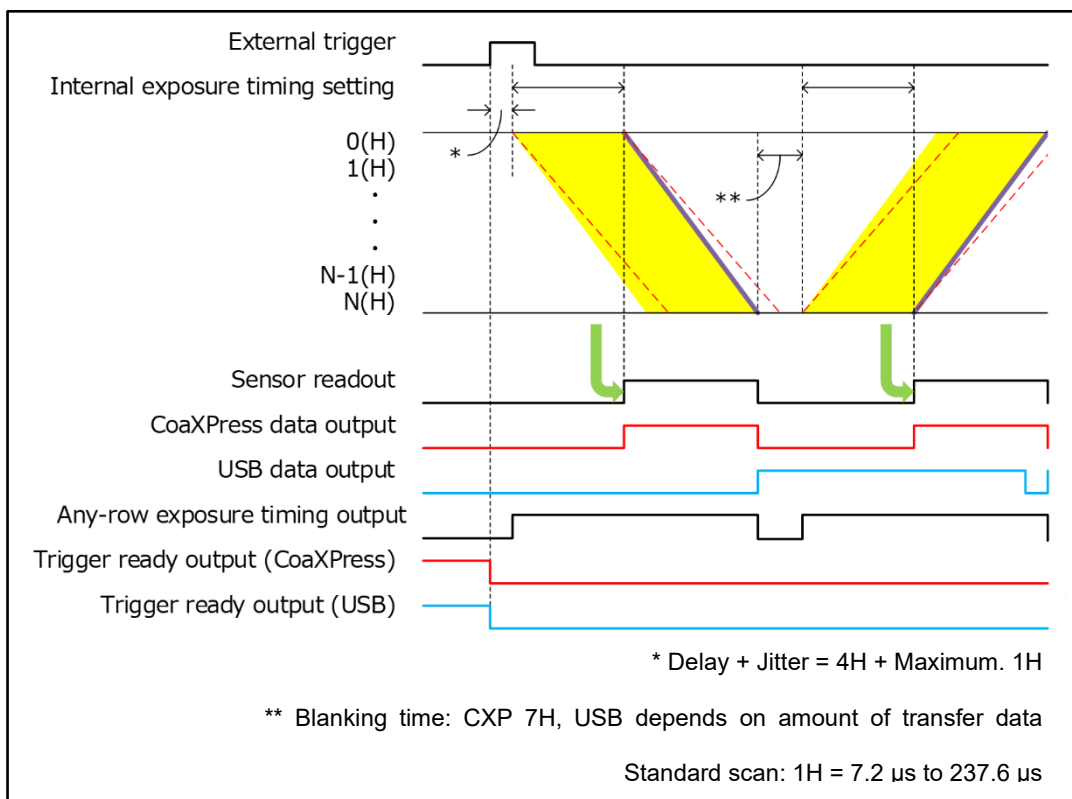

Figure 11-23 (Ex. rising edge, Top to bottom readout)

11-2-6 TRIGGER OUTPUT

The camera provides a range of trigger output signals to synchronize with an external instrument and the camera becomes the master and the external instrument becomes the slave.

There are three different trigger output functions as follows.

- Any row exposure timing output
- Programmable timing output
- Trigger ready output

Also, it can output continuous High output (High output fixed) or continuous Low output (Low output fixed). They are output from Timing out connector.

Note

- The Lightsheet Readout Mode does not have the period where all lines expose at the same time. The Global exposure timing output is not output.

(1) Any row exposure timing output

Global exposure timing output shows the global exposure timing where all lines expose at the same time. While the any row exposure timing shows when any of the rows.

(2) Programmable timing output

By using the programmable timing output, synchronizing with external devices is simple. A system which needs simple timing signal does not require a delay unit or pulse generator. It is possible to program and output a pulse that has an optional pulse width and an optional delay time to Read End (the end of readout timing), Vsync, Input trigger signal or Hsync. The range of delay is 0 μ s to 10 s, and the range of pulse width is 1 μ s to 10 s.

The relation between the parameter which can be set with each reference signal, and an output signal becomes as shown below.

Reference signal	Output signal
Read End	The signal with the preset pulse width is output after the preset delay from the end of the sensor readout.
Vsync	The signal with the preset pulse width is output after the preset delay from the start of the sensor readout
Input trigger signal	The signal with the preset pulse width is output after the preset delay from the input signal.
Hsync	The signal with the preset pulse width is output after the preset delay from the horizontal synchronized signal in the camera.

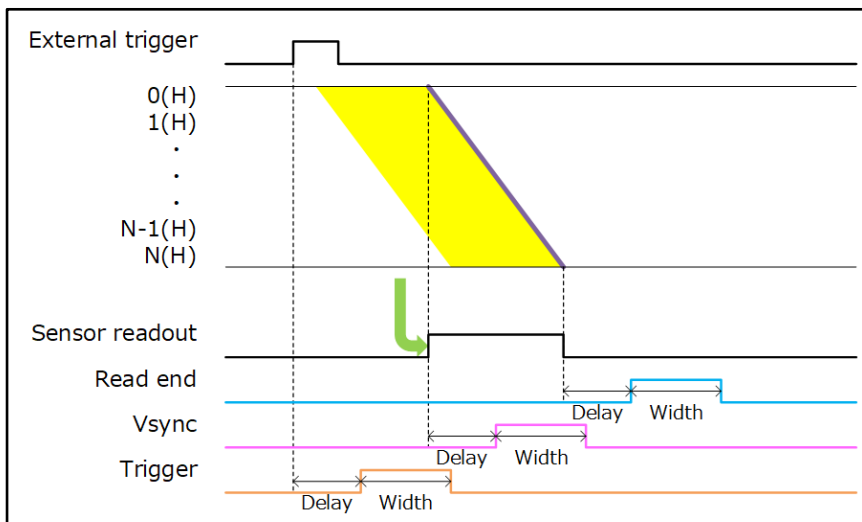

Figure 11-24 Programmable timing output (Top to bottom readout)

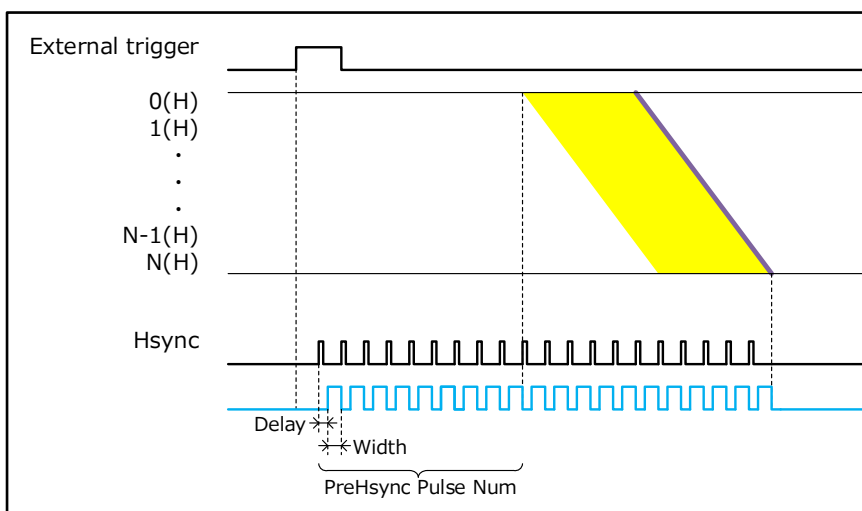

Figure 11-25 Programmable timing output referenced with Hsync (Top to bottom readout)

When you choose Hsync for the reference of programmable timing output, camera can output some pulses before start the exposure. It is called as Pre-Hsync. You can set the number of Pre-Hsync.

(3) Trigger ready output

This output behaves the same operation as Normal Area Mode and Lightsheet Readout Mode. Refer to 11-1-7(4) "Trigger ready output" for the details.

11-3 REAL-TIME DEFECT PIXEL CORRECTION

There are a few white spots which is caused by failure in part of the silicon wafer in CMOS image sensor. The camera has real-time pixel correction features to improve image quality.

The correction is performed in real-time without sacrificing the readout speed at all. This function can be turned ON and OFF. (Default is ON)

User can choose the correction level for white spots depend on required image quality.

Correction Level for white spots	Number of pixels to be corrected
High	Thousands of pixels
Medium (Default)	Tens of pixels
Low	Several pixels

11-4 DATA REDUCTION FUNCTIONS

The camera provides 9.4 megapixels resolution at 120 fps and 16 bit of gradation.

Then the camera outputs 2.2 GB of data per second, and large capacity of storage device would be necessary to store such a large amount of data.

The amount of data can be reduced by 12 bit or 8 bit digital output. The amount of data can be three quarters of original 16 bit data and each pixel have 4096 steps of gradation with 12 bit digital output. And, with 8 bit digital output, the amount of data can be the half of original 16 bit data and each pixel have 256 steps of gradation. When you use USB interface, the frame rate can be faster with 12 bit and 8 bit digital output.

The steps of gradation for each pixel would be reduced with 12 bit and 8 bit digital output. However, the look up table function can minimize the lack of gradation by choosing required range of intensity level. User can specify the range of intensity level for the look up table by 16 bit value.

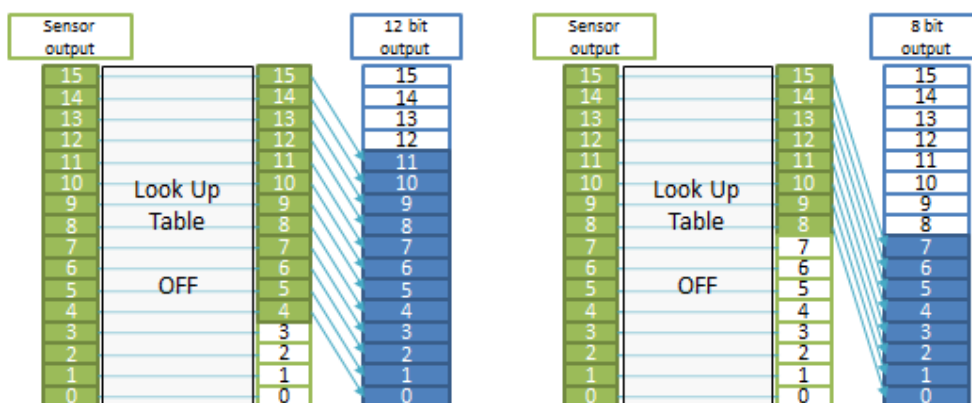

Figure 11-26 LUT OFF

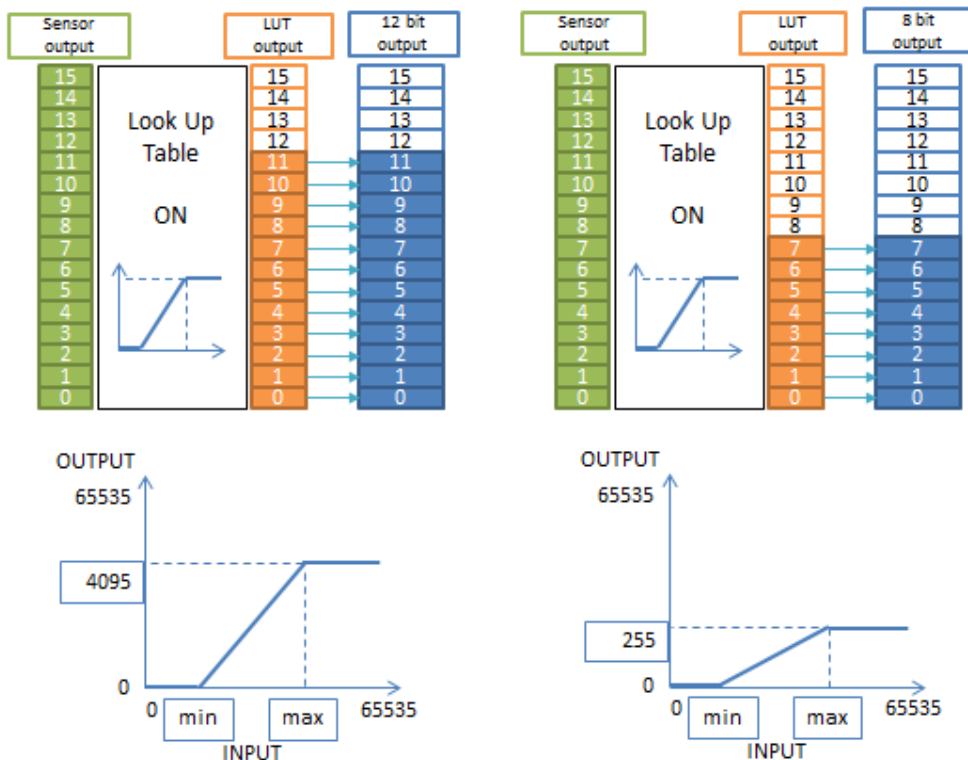

Figure 11-27 LUT ON

Note

- Refer to 11-1-4 Normal Area Mode "FRAME RATE CALCULATION" or 11-2-3 Lightsheet Readout Mode "FRAME RATE CALCULATION" about the frame rate when you use USB interface.

11-5 MASTER PULSE

The camera has master pulse function which can generate pulses that is independent of the exposure or readout timing of image sensor. External trigger mode can work synchronized with the timing pulses that the master pulse generates, except for External trigger mode in Lightsheet Readout Mode. The master pulse can be set as a reference signal of the programmable timing output, so it is possible to set up a synchronous system with peripheral devices without external pulse generator.

This function can be turned ON and OFF. (Default is OFF)

The master pulse supports free running mode, start trigger mode and burst mode. The range of interval time is 5 μ s to 10 s, and the step is 1 μ s for the master pulse.

(1) Free running mode

The camera generates pulses inside of the camera during the master pulse is ON.

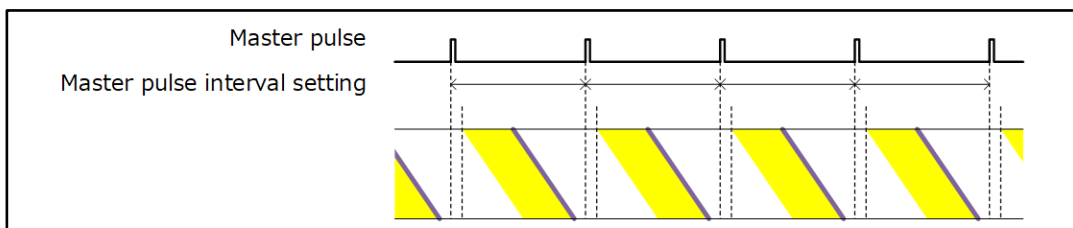

Figure 11-28 (Camera: Normal area, Edge trigger mode)

(2) Start trigger mode

The camera starts generating pulses inside of the camera by input trigger signal.

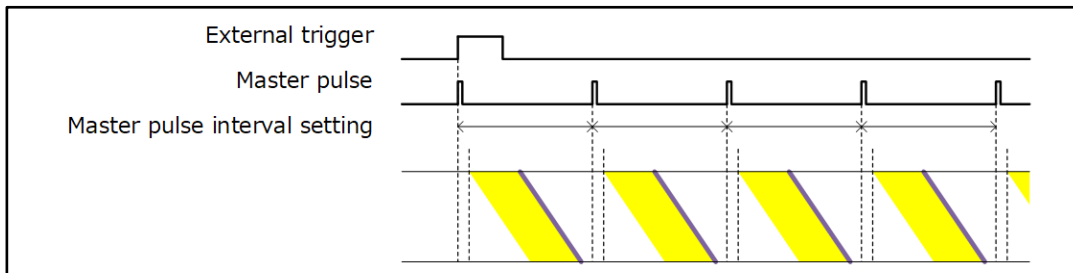

Figure 11-29 (Camera: Normal area, Edge trigger mode)

(3) Burst mode

The camera starts generating pulses inside of the camera by input trigger signal, and the camera stops generating pulses after the specified number of pulses are generated. And then, the camera will be ready for the next input trigger signal.

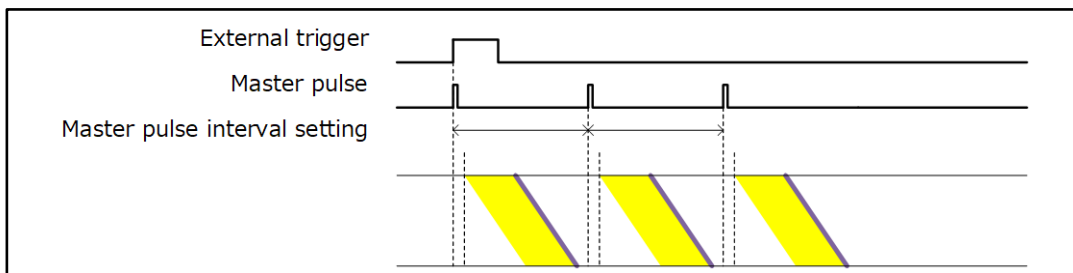

Figure 11-30 (Camera: Normal area, Edge trigger mode) (The number of pulses is specified as 3)

12. MAINTENANCE

12-1 CARE

Perform cleaning of this equipment with the dry soft cloth.



- Do not wipe with a damp cloth or unclean cloth.

Then, the glass window on the image sensor should be cleaned according to the following.

1. Blow the dust from the glass window with an air duster.
2. Moisten a lens cleaning paper with a little ethanol, and wipe over center area of the window, gently.
3. Confirm whether dust is not left.
Attach the camera to an optics, and check if there is dust or not under the uniform light condition. If there is dust on the image, clean the glass window again.



- Use Lens Cleaning Paper for cleaning of glass window in front of the image sensor.



- Use a plastic tweezers and take extra care not to scratch the glass window with the tweezers. Even with plastic tweezers, there is possibility to make scratch on the glass window in case tweezers touch it.



- Avoid touching the surrounding parts of image area when wiping the glass window.

12-2 INFORMATION ON COOLING WATER FOR THE CIRCULATING WATER COOLER



- Regarding handling cooling water and circulating water cooler, refer to instruction manual attached to the circulating water cooler.



- It is recommended to use soft water (except pure water) for cooling water.



- Do not use hard water for cooling. It cause inside of cooling water circulating path to be calcified or corroded and it result lower flow rate or water flow stop. When using hard water, conduct a process to soften water before use it.

12-2-1 WHEN USING COOLING WATER OTHER THAN RECOMMENDED

Note

[Pure water]

- Pure water is not appropriate for cooling water. There is possibility that pure water absorb component of cooling water path and it may cause corrosion. In addition pure water is easy to be polluted and cause impurity, sliminess or forming foreign substances. It cause lower flow rate or water flow stop.

[Distilled water / Deionized water]

- When using the camera inside clean room, it is possible to use distilled water or deionized water by conducting periodical check. However notice it increases possibility of corrosion inside cooling water path, lowering flow rate or water flow stop.
- Monthly check : Check water impurity, non-existence of sliminess, foreign particle is not mixed with water or not adhered inside water path and no unusual odor. If you find any of the issues, exchange cooling water and clean cooling water path.

[Soft water from tap]

- It is possible to use soft water from tap with conducting periodical change of cooling water and checkup. However notice it increases possibility of corrosion inside cooling water path, lowering flow rate or water flow stop.
- Monthly check : Check water impurity, non-existence of sliminess, foreign particle is not mixed with water or not adhered inside water path and no unusual odor. If you find any of the issues, exchange cooling water and clean cooling water path.
- Exchange cooling water every 3 months.
- Clean cooling water path every 6 months.

[Bottled water]

- One example of soft water which is commonly available is mineral water (Hardness less than 70). Check hardness of water by referring product information of bottled water manufacturer.

13. TROUBLESHOOTING

If an abnormality occurs, look up the possible causes in the following tables and, if necessary, report the details to Hamamatsu subsidiary or your local distributor.

13-1 IMAGE IS NOT TRANSFERRED

Cause	Measures	Chapter
AC adapter or other cable is loose	Reconnect the cable	7
AC adapter or other cable is broken	Replace the cable	7

13-2 ALTHOUGH IMAGES ARE TRANSFERRED

Conditions	Cause	Measures	Chapter
Scratches or discoloration visible on the screen	Lens is dirty	Wipe the lens	12
Image is blurred	Lens is not focused	Contact a Hamamatsu subsidiary or your local distributor	17
	Condensation appear	Confirm the operating environmental conditions	8
Only shadowed images are output	Lens mount cap has been left on	Remove the cap	
	Amount of light is too much or too low	Adjust amount of light	
All screens overflow	Too much amount of light	Reduce amount of light	
Noise appears on the screen	Exogenous noise	Find and remove cause	
	Poor connection of internal connector	Contact a Hamamatsu subsidiary or your local distributor	17
	Defective circuit system	Contact a Hamamatsu subsidiary or your local distributor	

14. SPECIFICATIONS

14-1 CAMERA SPECIFICATIONS

(1) Image quality specifications

Imaging device	qCMOS image sensor	
Effective number of pixels	4096 (H) × 2304 (V)	
Pixel size	4.6 μm × 4.6 μm	
Effective area	18.841 mm × 10.598 mm	
Conversion factor *1	0.107 electrons / count	
Readout noise *1	Standard scan	0.43 electrons (rms)
		0.39 electrons (median)
	Ultra quiet scan	0.30 electrons (rms)
		0.25 electrons (median)
Quantum efficiency *1	300 nm	50 %
	460 nm	85 %
	900 nm	30 %
Full well capacity *1	7000 electrons	
Dynamic range *1, 2	23 000 : 1 (rms)	
	28 000 : 1 (median)	
Dark current *1	Cooling temperature: -20 °C	0.016 electrons / pixel / s
	Cooling temperature: -35 °C	0.006 electrons / pixel / s
Dark offset	Binning OFF	200 counts
	Binning ON (2×2)	800 counts
	Binning ON (4×4)	3200 counts
Dark signal non-uniformity (DSNU) *1, 3	0.06 electrons r.m.s.	
Photo response non-uniformity (PRNU) (3500 electrons) *1, 3, 4	Less than 0.1 % r.m.s.	
Linearity error *1 (EMVA 1288 standard) *1	0.5 %	

* 1 Typical value.

* 2 Calculated from the ratio of the full well capacity and the readout noise at ultra quiet scan.

* 3 When using the Ultra Quiet scan.

* 4 Calculated from 1000 images of the center 1500 × 1500 pixels.

(2) Functional specifications

Sensor mode	Area readout / Lightsheet readout / Photon number resolving *1	
Readout mode	Full resolution readout / Binning readout *2 / Sub-array readout *3	
Exposure time	Standard scan	7.2 μ s to 1800 s (7.2 μ s step)
	Ultra quiet scan	33.9 μ s to 1800 s (33.9 μ s step)
Readout time *4, 5	Standard scan	8.330 ms
	Ultra quiet scan	39.27 ms
Frame rate	Refer to [Frame rate](P.73)	
Lightsheet readout mode	Variable row interval time (1H)	Available: 7.2 μ s to 237.6 μ s
	Readout time *4	8.330 ms to 274.9 ms
	Readout direction	Top to bottom readout / Bottom to top readout / Bidirectional readout / Reverse bidirectional readout
External trigger input mode	Area readout mode / Photon number resolving mode	Edge trigger / Global reset edge trigger / Level trigger / Global reset level trigger / Synchronous readout trigger / Start trigger
	Lightsheet readout mode	Edge trigger / Start trigger
Software trigger mode	Area readout mode / Photon number resolving mode	Edge trigger / Global reset edge trigger / Start trigger
	Lightsheet Readout Mode	Edge trigger / Start trigger
External trigger input connector	External input (SMA connector)	
External trigger input level	TTL / 3.3 V LVCMOS	
External trigger input polarity	Negative / Positive	
External trigger input delay	0 μ s to 10 s (1 μ s step)	
Trigger times (Synchronous readout trigger)	1 to 10 000	
Trigger output	Global exposure timing output / Any row exposure timing output / Trigger ready output / 3 programmable timing outputs / High output / Low output	
Trigger output level	3.3 V LVCMOS	
Trigger output polarity	Negative / Positive	
Programmable timing output	Reference signal	Read End / Hsync *6 / Vsync / Trigger
	Delay	0 μ s to 10 s (1 μ s step)
	Pulse width	1 μ s to 10 s (1 μ s step)
Master pulse mode	Pulse mode	Free running / start trigger / burst
	Pulse interval time	5 μ s to 10 s (1 μ s step)
	Pulse burst number	1 to 65 535
Digital output	16 bit / 12 bit / 8 bit	
Image processing function *7	Dark offset correction (Always on)	
	Pixel gain correction (Always on)	
	Defect pixel correction (ON or OFF, hot pixel correction 3 steps)	
Interface	CoaXPress (Quad CXP-6) / USB 3.1 Gen 1	

* 1 Readout time, Exposure time and frame rate when using photon number resolving mode are as same as that of Area readout mode.

* 2 Digital binning, 2 \times 2, 4 \times 4. At Area readout mode and photon number resolving mode.

* 3 Minimum settable step of the size and position are as follows: It is in only the case that the camera is used with DCAM-API.

	Horizontal size	Vertical size	Horizontal position	Vertical position
Area readout mode	4 pixel steps	4 line steps	4 pixel steps	4 line steps
Lightsheet readout mode	1 pixel step	4 line steps	1 pixel step	4 line steps
Camera only	256 pixel steps	4 line steps	4 pixel steps	4 line steps

- * 4 At full resolution readout.
- * 5 Valid 4 digits and rounded up to 5th digit.
- * 6 At Lightsheet readout mode.
- * 7 At Area readout mode and Light sheet readout mode.

[Frame rate] *1		at CoaXPress	at USB 3.1 Gen 1
at Full resolution	Standard scan	120 fps	17.6 fps
	Ultra quiet scan	25.4 fps	17.6 fps
at Vertical 4 lines	Standard scan*2	19 841 fps	4084 fps
	Ultra quiet scan	4208 fps	3682 fps

* 1 Valid 3 digits and rounded down to 4th digit.

* 2 When using frame bundle function on DCAM-API.

(3) Mechanical specifications

Cooling method	Forced-air cooled / Water cooled	
Cooling temperature	Forced-air cooled (Ambient temperature: +25 °C)	-20 °C
	Water cooled (Water temperature: +25 °C, Ambient temperature: +25 °C)	-20 °C
	Water cooled (Max cooling) (Water temperature: +20 °C, Ambient temperature: +20 °C)	-35 °C *1
Lens Mount	C15550-22UP	C-mount
	C15550-22UP01	F-mount

* 1 Typical value.

(4) Power supply specifications

Camera	Input power supply	DC 12 V
	Typical output	---
	Power consumption	84 W
AC adapter	Input power supply	AC 100 V to AC 240 V 50 Hz / 60 Hz 2.5 A
	Typical output	DC 12 V 8.34 A
	Power consumption	155 VA

Note

- Fluctuations of input power supply voltages are not to exceed $\pm 10\%$ of the nominal voltage.

(5) Operating environment

Ambient operating temperature	0 °C to + 40 °C
Ambient storage temperature	-10 °C to + 50 °C
Ambient operating humidity	30 % to 80 %, no condensation
Ambient storage humidity	Less than 90 %, no condensation
Place of operating	Indoor, altitude up to 2000 m

(6) Dimensional outline and weight

C15550-22UP (C-mount type)	Dimensional outline	110 mm (W) × 118 mm (H) × 141.6 mm (D)
	Weight	Approx. 3.0 kg (Camera only)
C15550-22UP01 (F-mount type)	Dimensional outline	110 mm (W) × 118 mm (H) × 170.6 mm (D)
	Weight	Approx. 2.9 kg (Camera only)



- Be careful not to drop the camera when moving it as the weights of C15550-22UP and C15550-22UP01 are approx. 3.0 kg and 2.9 kg respectively.

Note

- Refer to 15 "DIMENSIONAL OUTLINES" for detail of dimensions.

(7) Applicable standards

EMC	EN61326-1: 2013 Class A Emission limits: CISPR 11 Group1 Class A Immunity requirements: Table2		
	Function performance and operation mode in immunity tests	Judgment criteria A	Intensity fluctuation of image is within ± 5 %.
		Judgment criteria B	Though the operating function is temporarily impaired, it automatically return to normal operation during EMC test.
		Judgment criteria C	It returns to normal operation reboot the device.
Restoration procedure in immunity tests	Restart the device after exiting the software and turning off the power to the device.		
RoHS	EN IEC 63000:2018		
FCC	47 CFR FCC Part15 Subpart B Class A		

14-2 CONDENSATION

At the Water-cooling, if ambient temperature and ambient humidity become high, condensation will take place easily. Use the camera under the environment where condensation will not take place referring to the following graph.

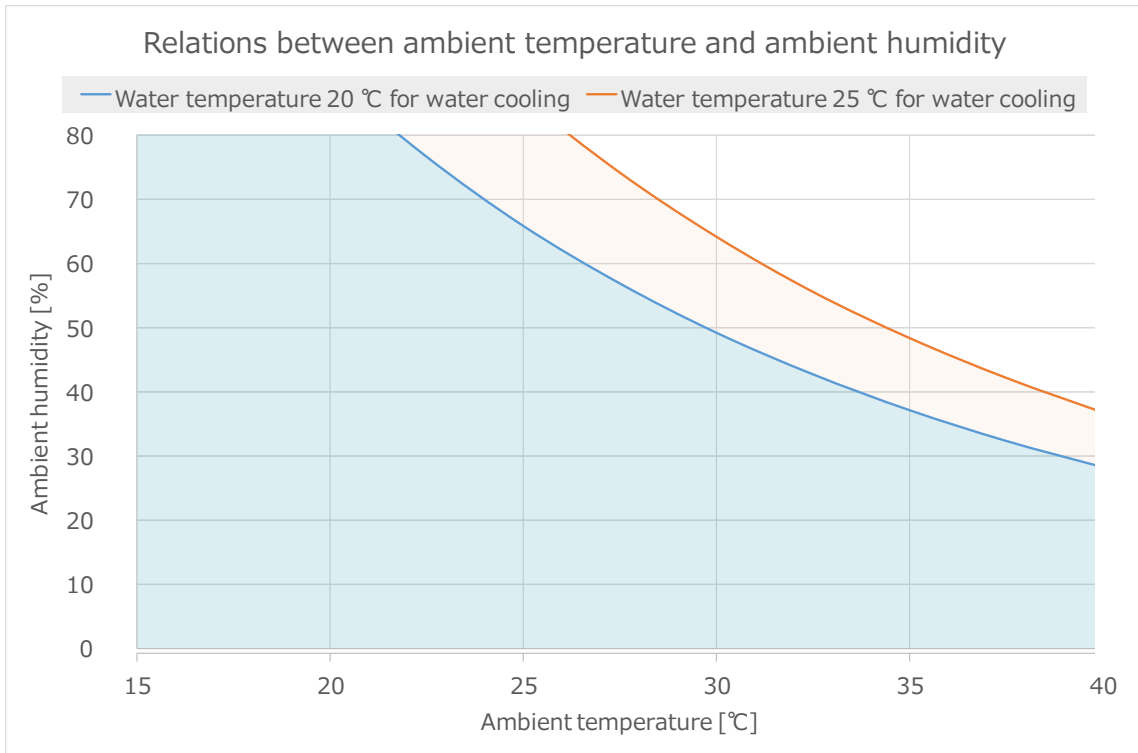

Graph 14-1

14-3 SPECTRAL RESPONSE CHARACTERISTICS (TYP.)

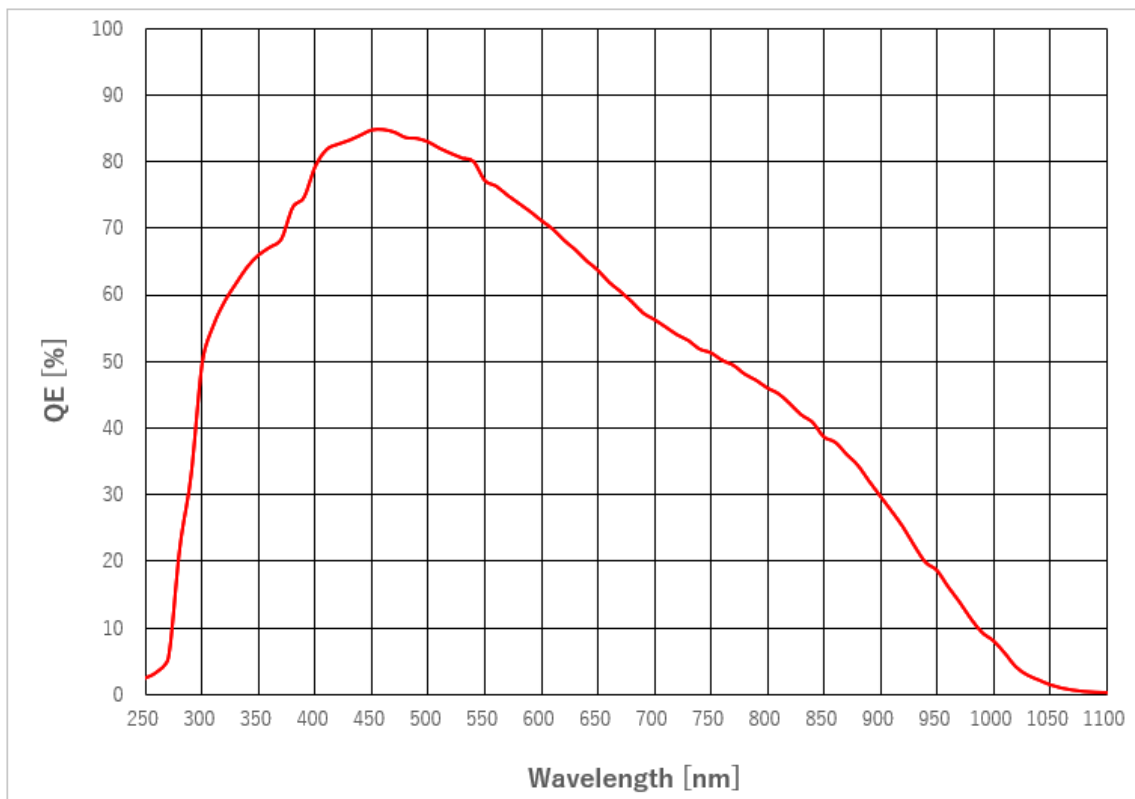

Graph 14-2

15. DIMENSIONAL OUTLINES

15-1 C15550-22UP

(Unit: mm)

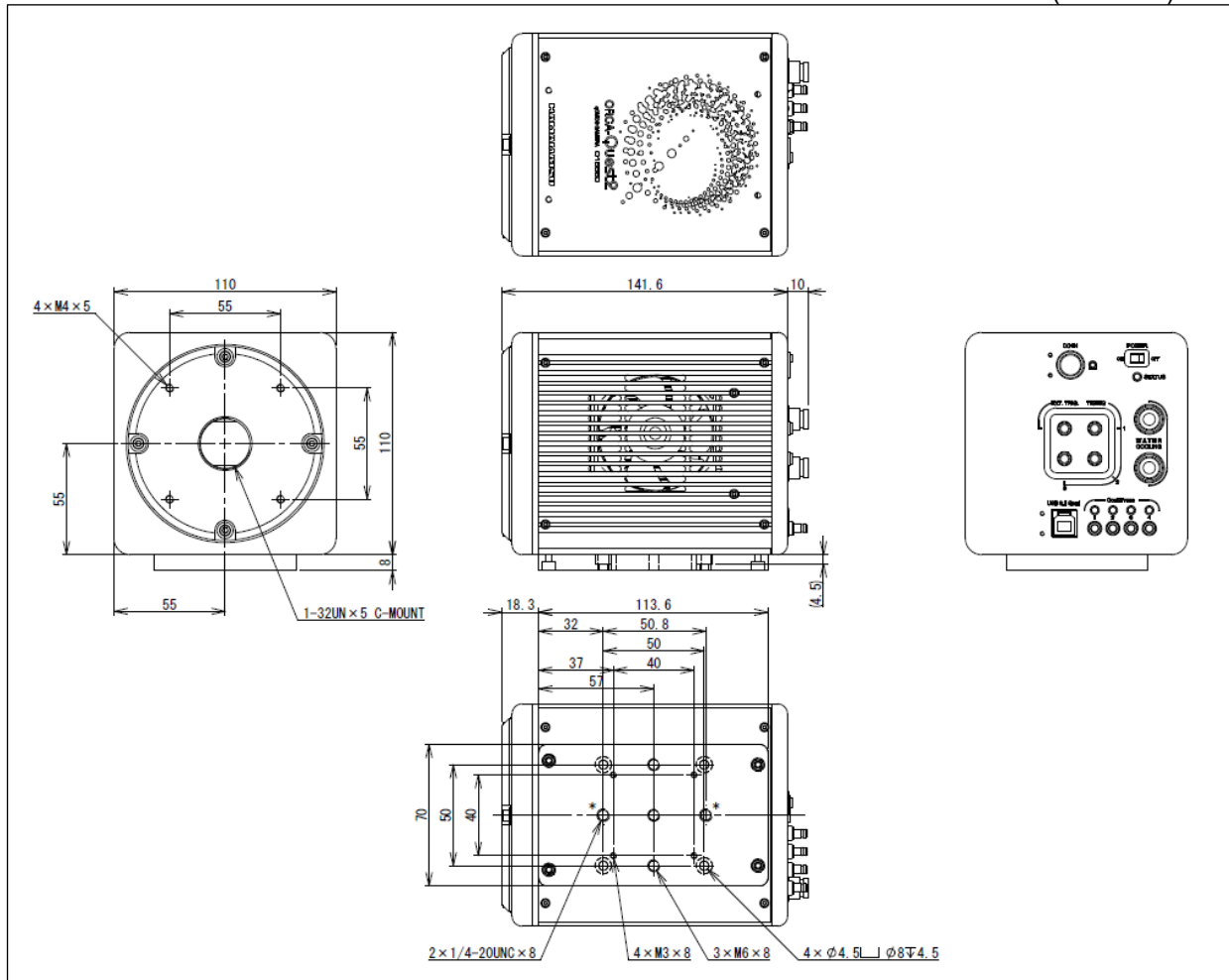

15-2 C15550-22UP01

(Unit: mm)

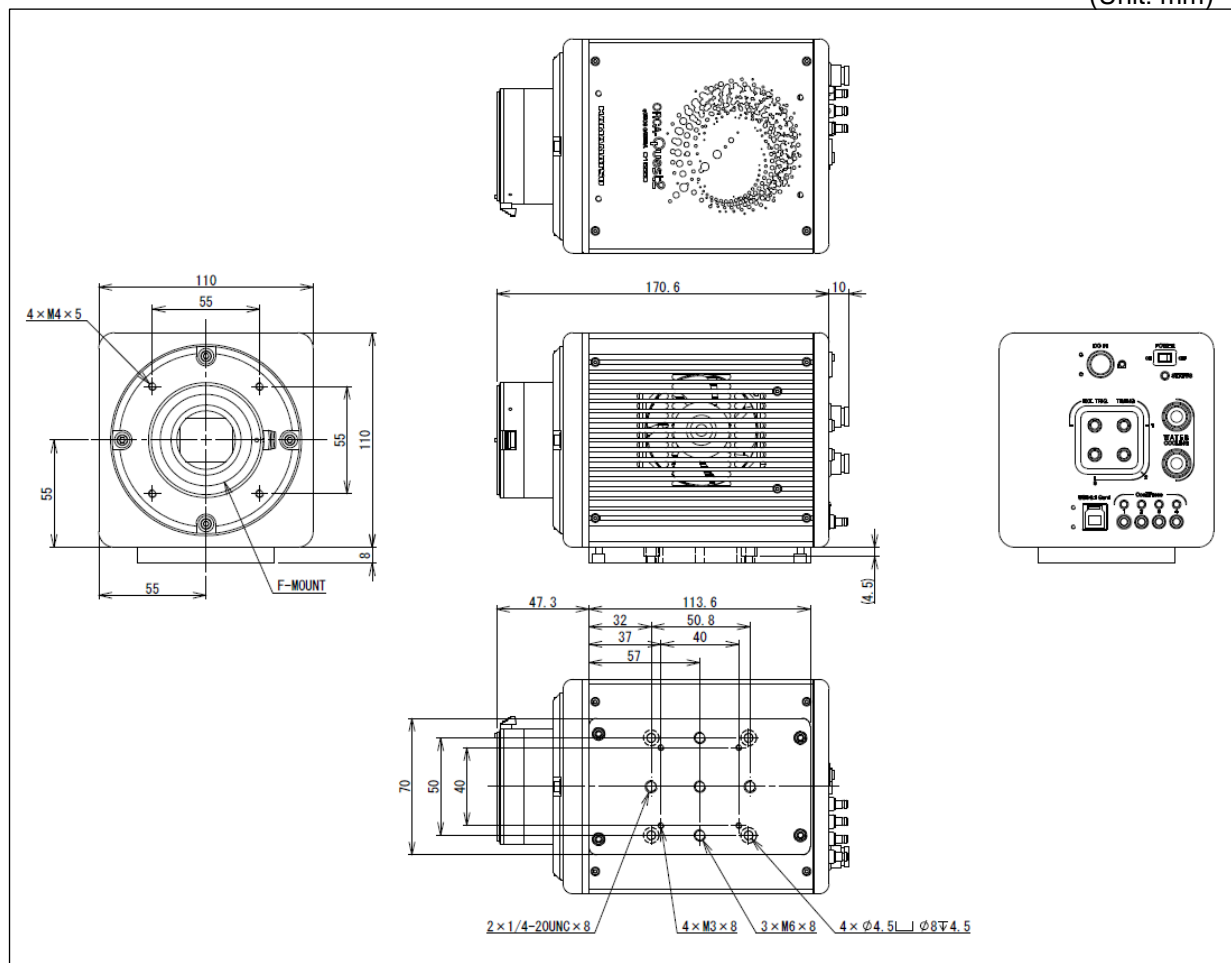

16. WARRANTY

Hamamatsu Photonics have fully inspected this camera and checked that its performance conforms to specifications. In the unlikely event of a breakdown or other malfunction, contact a Hamamatsu subsidiary or your local distributor.

16-1 BASIC WARRANTY

1. Unless otherwise stated by Hamamatsu subsidiary or your local distributor, this camera is under warranty for 24 months from the delivery date.
 - Degradation with cosmic rays and the radiation (X-rays, gamma rays, UV light, etc.) of CMOS image sensor is excepted.
2. The warranty only covers defects in the materials and manufacturing of the camera. You may be liable for repairs during the warranty period in the event of a natural disaster or if you handle the camera contrary to the instructions in this manual, use it without due caution, or try to modify it.
3. We will repair the camera or replace it, subject to availability, free of charge within the terms of the warranty.

16-2 REPAIRS

1. If you notice anything wrong with the camera, confirm whether or not it is malfunctioning by referring to the TROUBLESHOOTING in this instruction manual. You must first clarify the symptoms in order to avoid any misunderstanding or error.
2. If you have any trouble or are unclear about anything, contact a Hamamatsu subsidiary or your local distributor giving the product name, serial number and details of the problem. If Hamamatsu Photonics consider the problem to be a malfunction, we will decide whether dispatch an engineer or have the camera returned to us for repairs.

17. CONTACT INFORMATION

Manufacturer

HAMAMATSU PHOTONICS K. K., Systems Division

812 Joko-cho, Chuo-ku, Hamamatsu City, Shizuoka Pref., 431-3196, Japan
Telephone (81) 53-431-0124, Fax: (81) 53-435-1574
E-mail: export@sys.hpk.co.jp

Local contact information worldwide can be found at:

www.hamamatsu.com

- *The contents of this manual are subject to change without notice.*
- *The unauthorized duplication or distribution of all or part of this manual is strictly prohibited.*
- *If one of the following is found, please contact Hamamatsu. (refer to the local contact information).*
 - *Contents of the manual are illegible, incorrect or missing.*
 - *Pages of the manual are missing or in the wrong order.*
 - *The manual is unclean.*