

ORCA-Flash4.0 LT3 Digital CMOS camera C11440-42U40 Instruction manual

Thank you for your purchase

 **CAUTION**

- Follow the safety precautions in Chapter 1 in order to avoid personal injury and damage to property when using this camera. The manual describes the correct handling method of the camera and provides instructions that should be followed to avoid accidents. Read this manual carefully before using this camera. After reading this manual, store it in a location where you can refer to it at any time.



Ver. 1.1
Dec. 2022

HAMAMATSU PHOTONICS K.K.

1. SAFETY PRECAUTIONS







1-1 SYMBOLS

The following symbols can be found on this camera:

	Direct current
	Alternating current

1-2 CLASSIFICATION OF WARNINGS

We have classified the warnings symbols that appear in this instruction manual and on the camera as follows for your convenience. Make sure that you fully understand them and follow the instructions they contain.

 WARNING	Improper handling of the camera without observing these warnings could lead to serious injury to the user and even death.
 CAUTION	Improper handling of the camera without observing these cautions could lead to personal injury to the user or damage to property.
 Note	This symbol indicates a note to help you get the best performance from the camera. Read the contents of the note carefully to ensure correct and safe use. Failure to observe one of these notes might impair the performance of the camera.
	This symbol indicates a cautionary item that should be followed when handling the camera. Read the contents carefully to ensure correct and safe use.
	This symbol indicates an action that is forbidden. Read and follow the instructions carefully.
	This symbol indicates a compulsory action or instruction. Read and follow the instructions carefully.

 **WARNING**



Power supply

Use the camera with the indicated voltage on the rating sticker. Using a different voltage can damage the camera and lead to fire or electric shock.



Cables

Do not to place heavy objects on cables or bend them excessively. Doing so can damage the cables and lead to fire or electric shock.



Power supply cord

Use the accessory power supply cord when using this camera.



AC adapter

Use the accessory AC adapter when this camera is used.



Do not touch the plug with wet hands. Doing so can lead to electric shock.



Do not attempt to dismantle or modify the camera

Doing so can also lead to damage and even injury, as some internal components become very hot or high voltage. Do not touch parts that are not indicated in this manual.



Do not insert a foreign substance into the camera

Such as combustible substances, metal objects or water to get inside the camera. These can damage the camera and lead to fire or electric shock.



In the event of an anomaly

Such as the image suddenly disappearing or the occurrence of a strange noise, a strange smell or smoke coming from the camera, immediately turn off the power switch and unplug the power supply cord and contact Hamamatsu subsidiary or your local distributor. Do not attempt to repair the camera yourself.

CAUTION



AC adapter

When unplugging the power supply cord, do not pull on the cord. Remove the plug from the outlet to avoid causing electric shock or fire.



When unplugging the AC adapter, do not pull on the cord. Remove the plug from the camera to avoid breakdown of the AC adapter or the camera.



If the camera is not in use for a long period of time, unplug the power supply cord from the outlet to avoid damaging the cord and causing electric shock or fire.



Connecting and disconnecting cables

Always turn off the camera before connecting and disconnecting cables.



Mounting the camera

When mounting the camera to a tripod or other fixture, use the optional base plate. Be careful that the mounting screw does not enter more than 8 mm from the surface of the base plate. Screwing it in further can impair normal operation.



Lenses (C11440-42U40)

Be careful not to screw the lens more than 7 mm into the C-mount of the camera. Doing so can scratch the protective glass. (Some wide-angle lenses in particular can have a thread of 7 mm or more.)



Shipping precautions

When transporting the camera by truck, ship, airplane, etc., wrap it securely in packaging material or something similar.



Strong impact

Do not subject the camera to strong shocks (such as dropping it). Doing so can damage the camera.



Operating environment

This camera is designed and tested for use in an industrial environment. If this camera is used in residential areas, EMI (electro-magnetic interference) may occur. This camera must not be used in residential areas.



Disposal

When disposing of the camera, take appropriate measures in compliance with applicable regulations regarding waste disposal and correctly dispose of it yourself, or entrust disposal to a licensed industrial waste disposal company. In any case, be sure to comply with the regulations in your country, state, region or province to ensure the camera is disposed of legally and correctly.

2. CHECK THE CONTENTS OF PACKAGE

When opening the package, check that the following items are included before use. If the contents are incorrect, insufficient, or damaged in any way, contact a Hamamatsu subsidiary or your local distributor before attempting to operate the camera.

Camera (C11440-42U40)	1
AC adapter	1
Power supply cord for AC adapter	1
Lens mount cap (attached to the camera)	1
C11440-42U40 Before Use (Booklet)	1
C11440-42U40 Instruction manual (CD-ROM)	1

[Option]

External trigger cable SMA-BNC 5 m	A12106-05
External trigger cable SMA-SMA 5 m	A12107-05
USB 3.0 cable A-MicroB 3 m	A12046-03
Frame grabber board with USB 3.0 A-MicroB 3m Cable	M9982-26
Adjustable pole for C11440-22CU	A11185-01
Base plate common for Flash4.0 chassis	A11186-01

Note

- The cable listed in option is highly recommended for use with the camera. The camera may not confirm to CE marking and FCC regulation if other type of cable is used with.

Note

- If you use the adjuster pole and the base plate, please refer to the respective installation manual.

3. INSTALLATION

Avoid using or storing this camera in the following places



- Places where the temperature is not the operating temperature indicated in the specifications.
- Places where the temperature is not the storage temperature indicated in the specifications.
- Places where the temperature varies greatly.
- In direct sunlight or near a heater.
- Places where the humidity levels are not the operating humidity levels indicated in the specifications and where the system may be exposed to liquid.
- Places where the humidity levels are not the storage humidity levels indicated in the specifications and where the system may be exposed to liquid.
- Close to a strong source of magnetism or radio waves.
- Places where there are vibrations.
- Places where the system may come into contact with corrosive gases (such as chlorine or fluorine).
- Places where there is a lot of dust.

How to place the camera (when the camera is placed on a table)



Do not place the camera the rear panel of the camera, which connectors are located, to be at the bottom. (Do not block ventilation openings.)

Do not block ventilation openings



To prevent overheating in the camera's interior, do not wrap the camera in cloth or any other material, or in any way allow the camera's ventilation ports to become blocked. If the camera is being operated in a closed environment, ensure clearance of at least 10 cm from both the intake and exhaust vents when setting up.

Contents

1. SAFETY PRECAUTIONS	1
1-1 SYMBOLS.....	1
1-2 CLASSIFICATION OF WARNINGS.....	1
2. CHECK THE CONTENTS OF PACKAGE	4
3. INSTALLATION	5
4. OVERVIEW	8
5. FEATURES	8
6. NAME AND FUNCTION OF PARTS	10
7. CONNECTION	12
7-1 CONNECTING OF CABLES	12
8. OPERATIONS	13
8-1 OPERATING PRECAUTIONS.....	13
8-2 PREPARING FOR IMAGING	13
8-3 IMAGING.....	14
8-4 END OF IMAGING.....	14
8-5 STARTUP DCAM CONFIGURATOR.....	15
9. DESCRIPTION OF VARIOUS FUNCTIONS	17
9-1 THEORY OF THE CMOS IMAGE SENSOR.....	17
9-2 NORMAL AREA MODE	19
9-2-1 Readout method (Scan mode)	19
9-2-2 Readout method (Scan speed).....	20
9-2-3 Camera operation modes	21
9-2-4 Frame rate calculation	22
9-2-5 Configuring exposure time.....	24
9-2-6 Timing chart of camera operation modes	25
9-3 REAL-TIME CORRECTION FUNCTIONS	35
10. PRECAUTION WHEN USING THE CMOS IMAGE SENSOR	36
11. MAINTENANCE	37
11-1 CARE	37
12. TROUBLESHOOTING	38
12-1 IMAGE IS NOT TRANSFERRED	38
12-2 ALTHOUGH IMAGES ARE TRANSFERRED	38
13. SPECIFICATIONS	39
13-1 CAMERA SPECIFICATIONS	39
13-2 SPECTRAL RESPONSE CHARACTERISTICS(TYP.)	42
14. DIMENSIONAL OUTLINES	43
14-1 C11440-42U40	43
15. WARRANTY	44
15-1 BASIC WARRANTY	44

15-2 REPAIRS.....44
16. CONTACT INFORMATION 45

4. OVERVIEW

C11440-42U40 is equipped with the new scientific image sensor, an advanced CMOS device that realizes the multiple benefits of high resolution, high readout speed, and low noise all at once.

The camera provides 4.0 megapixels resolution at 40 fps (frames/s) (and up to 25 000 fps by sub-array readout) with rapid rolling, and the camera can achieve 0.9 electrons (median) 1.5 electrons (rms) readout noise performance with standard scan. Moreover, the camera delivers high sensitivity through its on-chip micro lens, high dynamic range that makes the camera suitable for almost any scientific application from bright field imaging to low-light fluorescence imaging across a wide spectral range. Various external trigger functions and timing output functions ensure proper timing control with peripheral equipment to cover a wide range of applications.

The camera is the new scientific digital camera for life science microscopy, semiconductor inspection, x-ray scintillator readout or industrial imaging.

5. FEATURES

(1) Readout noise

In the camera, the pixel amplifier is optimized: it has high gain from optimizing the semiconductor process, and the difference among pixel amplifiers are greatly minimized. In addition, there is on-chip CDS (correlated double sampling) circuit, which plays an important role in achieving low noise. Moreover, the sensor features a split readout scheme in which the top and bottom halves of the sensor are readout independently, and the data of each horizontal line is read by 2 lines of column amplifier and A/D in the top and the bottom in parallel and simultaneously. As a result, it achieves very fast readout speed while keeping very good low-noise performance.

The camera has lower readout noise (0.9 electrons (median), 1.5 electrons (rms)) than the conventional cooled CCD camera. Moreover, high-speed readout (30 fps with 2048 pixels × 2048 pixels) with very low readout noise, which was impossible, can now be achieved.

In addition, the camera can achieve feature high-speed readout (40 fps with 2048 pixels × 2048 pixels) with rapid rolling (readout noise 1.3 electrons (median), 1.9 electrons (rms)).

(2) Cooling structure

In the camera, the CMOS image sensor is cooled down by a peltier element to suppress the dark current. The camera has a special chamber structure to avoid the condensation.

(3) Pixel number and pixel size

The CMOS image sensor has 6.5 μm × 6.5 μm pixel sizes that is equivalent to conventional CCD image sensor (2/3 inch, 1.3 megapixels). Also, the camera can observe a wider field of view because the pixel number is about 3 times that of the conventional CCD image sensor (2/3 inch, 1.3 megapixels)

(4) Readout method

The camera has a variety of readout modes. In addition to full resolution readout mode, sub-array readout and binning readout are supported.

(5) Frame rate

The CMOS image sensor realizes both low noise (0.9 electrons (median) 1.5 electrons (rms)) and high speed readout (30 fps with 2048 pixels x 2048 pixels) simultaneously, by a split readout scheme in which the top and the bottom halves of the sensor are readout independently, and the data of each horizontal line is read by 2 lines of column amplifier and A/D in the top and the bottom in parallel and simultaneously. In addition, the camera can achieve feature high-speed readout (40 fps with 2048 pixels x 2048 pixels) with rapid rolling (readout noise 1.3 electrons (median), 1.9 electrons (rms)).

(6) Real-time correction functions

When using the camera, there is a case that shading caused by uneven illumination or optics is not negligible in the image. Also, there are a few pixels in the CMOS image sensor that have slightly higher readout noise performance compared to surrounding pixels. For those cases, the camera has real-time offset level, shading and defective pixel correction features to further improve image quality. The correction is performed in real-time without sacrificing the readout speed at all.

(7) Interface

This camera has USB 3.1 Gen 1 interface. USB 3.1 Gen 1 interface is able to transfer 4 megapixels image with 40 fps. It is versatile interface. It transfers image with moderate transfer speed.

(8) Camera operation modes

The camera has three operation modes: 1) the free running mode, in which the exposure and readout timing are controlled by the internal microprocessor, and 2) the external trigger mode, in which the exposure and readout timing are decided by an external trigger. 3) the start trigger mode is used to start operating the camera by a trigger input for a continuous imaging.

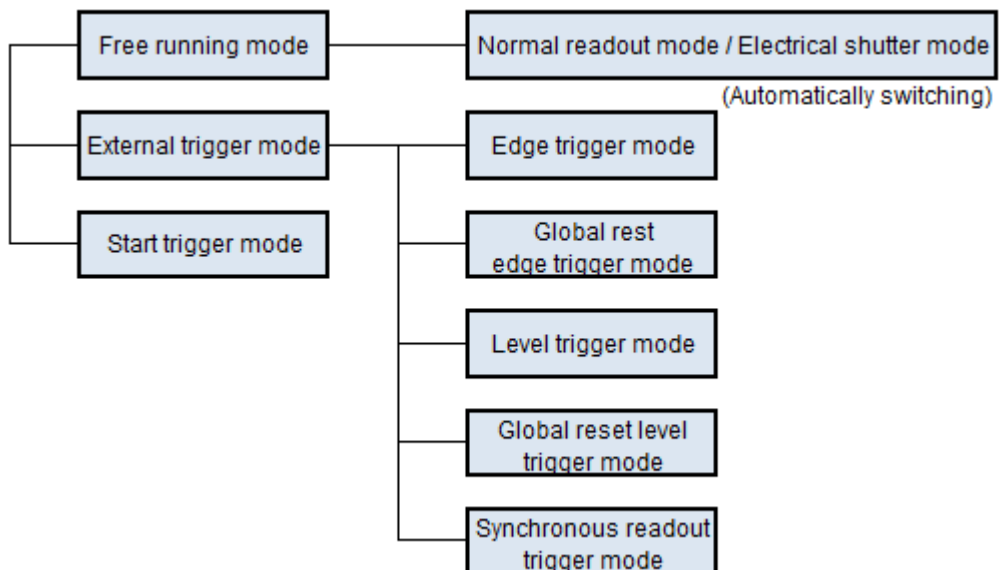

6. NAME AND FUNCTION OF PARTS

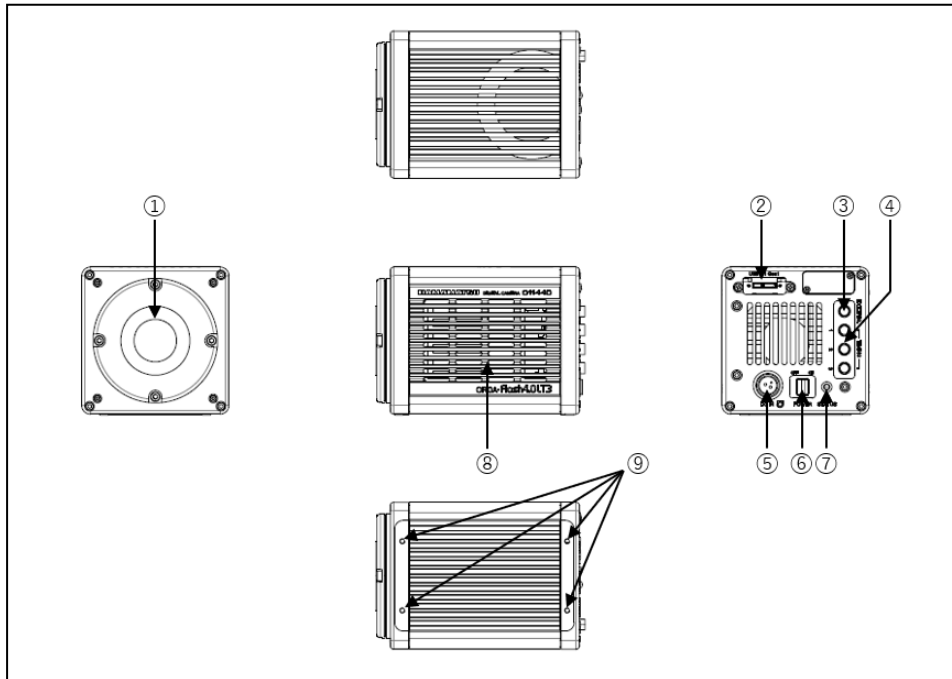

CAUTION

- Do not place the rear panel of the camera, which connectors are located, to be at the bottom (Do not block ventilation openings.).

① Lens mount

C11440-42U40 can be attached to C-mount lens or an optics system.

Note

- The depth of the C-mount is 7 mm. Screwing in the mount too far can scratch the glass surface.

② USB 3.1 Gen 1 interface connector [USB 3.1 Gen 1]

This is connected to the USB interface connector on the computer.

③ Trigger input connector [EXT.TRIG]

This is used when the camera is being operated using external synchronization. Input is TTL or 3.3 V LVCMOS level, and input impedance is 10 k Ω . When an external trigger is input, the trigger is activated at the falling or rising edge of the signal. (You can choose external trigger polarity between Negative and Positive.)

④ Timing out connector 1,2,3 [TIMING 1,2,3]

This is used when peripheral device(s) require synchronization with the camera. Output is 3.3 V LVCMOS level, and it is output though BUS TRANSCEIVER IC SN74LVC541. Output impedance is 33 Ω .

Note

- Determine termination according to cable length and so on.

⑤ DC power input connector [DC IN]

This is the power supply terminal. Use the accessory AC adapter.

⑥ **Power switch [POWER]**

The power is turned ON/OFF.

When the power switch is set to "ON", the camera turns on and starts initialization and the lamp blinks in green.

When the initialization is completed, the lamp color stays in green.

When the camera transfers data and the lamp color is orange.

When the power switch is set to "OFF", the camera returns to the power off state and the lamp turns off.

⑦ **STATUS lamp [STATUS]**

The LED indicates status of camera.

Lighting color	Status of power distribution
Turn off (no color)	Power off
Green (Blinking)	Initialization
Green (lighting)	Power on
Orange (lighting)	Data transfer
Red (lighting)	Heat up



CAUTION

- When the camera heats up, stop operation and unplug the AC adapter immediately.

⑧ **Air outlet**

This is the outlet for the heat ventilation.



- To prevent overheating inside the camera, do not wrap the camera in cloth or other material, or block the camera's ventilation.



- If the camera is being operated in an enclosed environment, ensure to keep clearance at least 10 cm from both intake and exhaust vents when setting up.

⑨ **Installation holes for base plate**

These are the holes to install the base plate.



- If you use the adjuster pole and the base plate, see each installation manual.

7. CONNECTION

7-1 CONNECTING OF CABLES

Refer to the figure below when connecting the various cables.

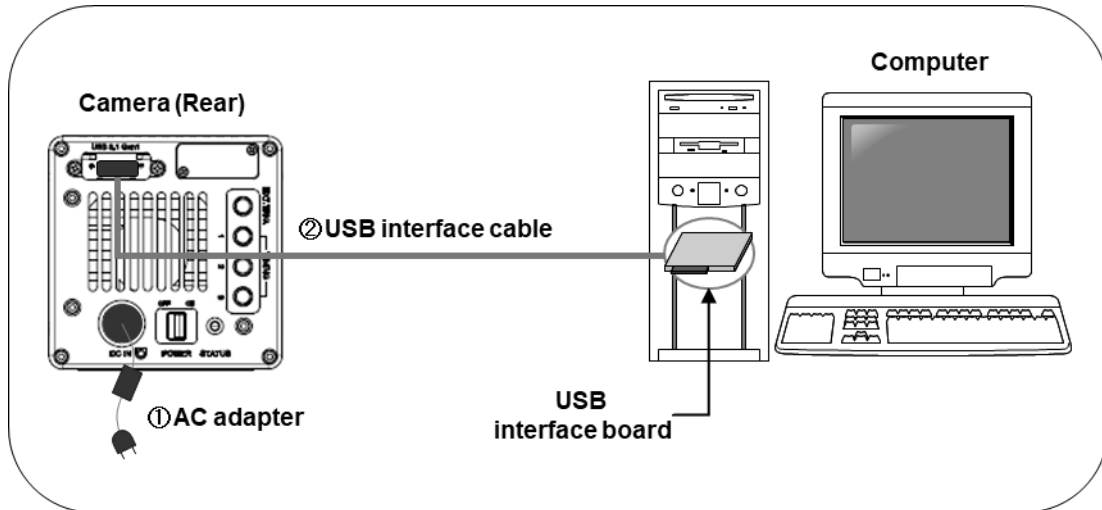

Figure 7-1



- When you connect cables, turn off the power supply of the camera and the peripheral devices.



- If you use the adjuster pole and the base plate, see each installation manual.

CAUTION

- Do not place the rear panel of the camera, which connectors are located, to be at the bottom (Do not block ventilation openings.).

① AC adapter

This is the cord to supply a power supply. Use the accessory AC adapter.

② USB interface cable (Option)

This is the cable to connect the USB interface connector of the camera and the USB interface connector on the computer.

Note

- Hamamatsu recommends A12046-03 optional USB interface cable for this camera. The camera complies with EMC and FCC regulations with using A12467-03 USB interface cable. Be careful that the camera with other interface cable may not fulfill the EMC and FCC directive requirements.

8. OPERATIONS

8-1 OPERATING PRECAUTIONS

Be careful of the following when you operate the camera.

(1) Cooling method

Cooling of this equipment is done using a Peltier element. With a Peltier element, when current is supplied, one surface is cooled, and the other surface is heated. The CMOS image sensor is positioned on the cooling side, and cooling is done by discharging the heat from the heated surface. This cooling method is passive air-cooling.

(2) Ambient temperature

The recommended ambient temperature for camera operation is between 20 °C and 25 °C. Thus, the maximum temperatures to which the CMOS image sensor can be cooled, and the stability of the cooled temperature, are affected by the ambient temperature. The ambient temperature should be maintained at a constant temperature in order for cooling to be effective.

(3) Protection circuit

This camera's thermoelectric cooling device is protected by a thermal protection circuit. If the internal temperature of the camera becomes abnormally hot, the protection circuit operates to inform the user by a buzzer alarm (beep tone) and lighting the camera's red LED light while simultaneously cutting the current supply to the Peltier element. As soon as this protection is implemented, turn off the power switch and unplug the AC supply. Then remove the cause of the overheating.

(4) Fan speed

This camera has a function to change a fan speed in 3 stages [Fast, Middle, Slow] to suppress camera vibration caused by a fan. Fast speed achieves the maximum air volume and it is the default factory setting. The usable temperature of this camera varies depending on the fan speed.

Fan speed can be changed by software which is called, "DCAM Configurator". (refer to 8-5 "STARTUP DCAM CONFIGURATOR").

8-2 PREPARING FOR IMAGING

Use the following procedure when starting operating of the camera.

- (1) Connect devices as shown in Figure 7-1 before you start operation.
- (2) Turn on the computer's power switch.

The cooling temperature becomes stable about 5 minutes after cooling begins.



- When the cables are connected, confirm the power switch of peripheral device is in the OFF position.

8-3 IMAGING

Start the control and imaging with the application software.

Note

- Please refer to the instruction manual attached to the software for the way of using it and the details.

8-4 END OF IMAGING

Carry out the procedure below when imaging is finished.

- (1) End the imaging or transmission of image data with the application software.
- (2) Turn off the power to the peripheral device.

8-5 STARTUP DCAM CONFIGURATOR

The following is a procedure to startup “DCAM Configurator”.

- (1) Open “Setup.exe” in the DCAM-API software’s folder.
If the DCAM-API software is not installed on your computer, insert the media of DCAM-API software in the slot of your computer.
When it is inserted, “DCAM-API Setup” window is displayed automatically.
- (2) Click on “Tools”.

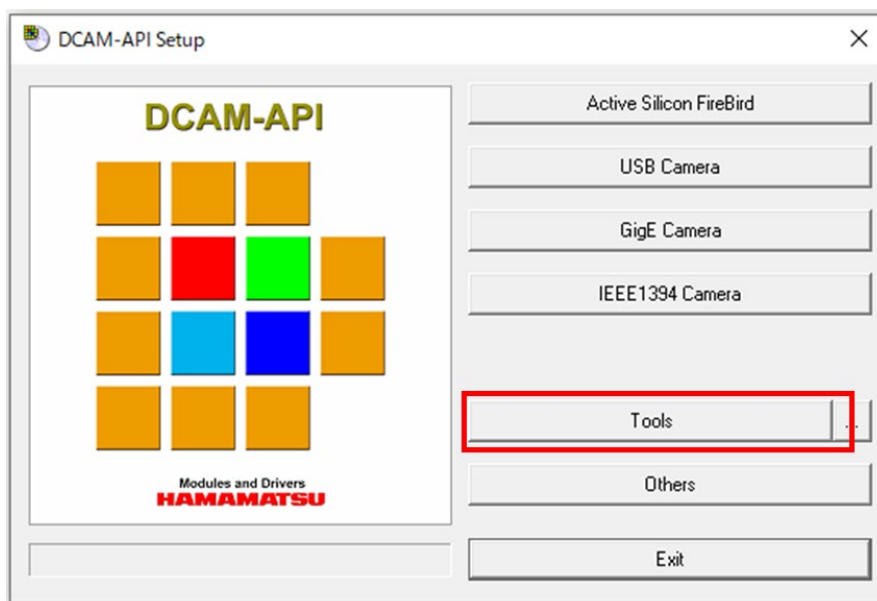

- (3) Click on “DCAM Configurator”.

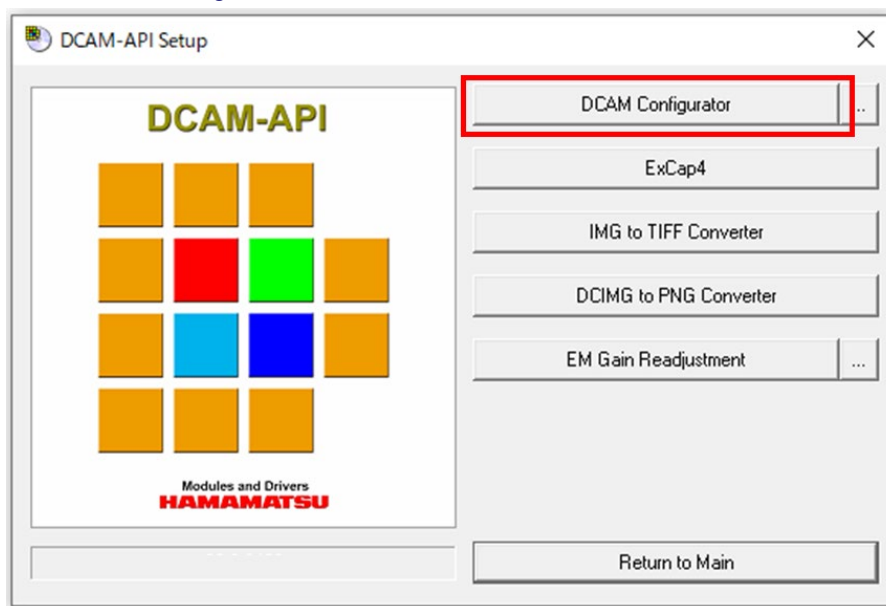

(4) "DCAM Configurator" window is displayed. The startup is completed with this.

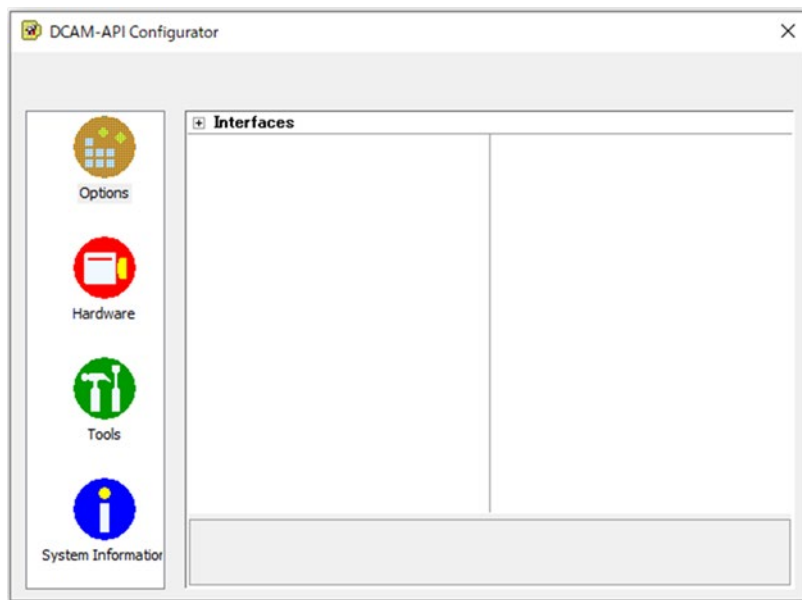

- Even if the camera's power supply is turned off, the state of setting is kept.
- The state of setting can confirm according to "Hardware" icon on DCAM Configurator window.



- After the startup, operate DCAM Configurator according to "DCAM Configurator Instruction manual". The manual is displayed when the following buttons on DCAM Setup window are clicked.

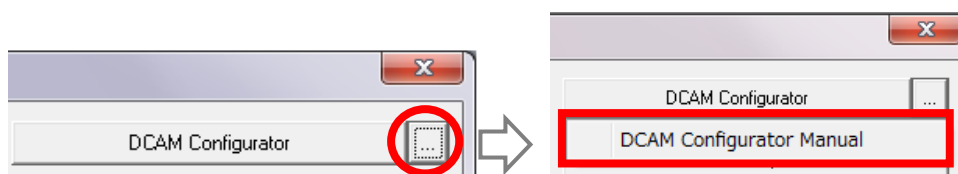

9. DESCRIPTION OF VARIOUS FUNCTIONS

9-1 THEORY OF THE CMOS IMAGE SENSOR

The pixel of the CMOS image sensor is composed of the photodiode and the amplifier that converts the charge into voltage. Entered light is converted to charge and converted to voltage in the pixel. The voltage of each pixel is output by switching the switch one by one. (Figure 9-1)
The scientific CMOS image sensor used in this camera has an on-chip CDS (correlated double sampling) circuit, which plays an important role in achieving low noise. In addition, the CMOS image sensor realizes both low noise and high speed readout simultaneously, by a split readout scheme in which the top and the bottom halves of the sensor are readout independently, and the data of each horizontal line is read by 2 lines of column amplifier and A/D in the top and the bottom in parallel and simultaneously.

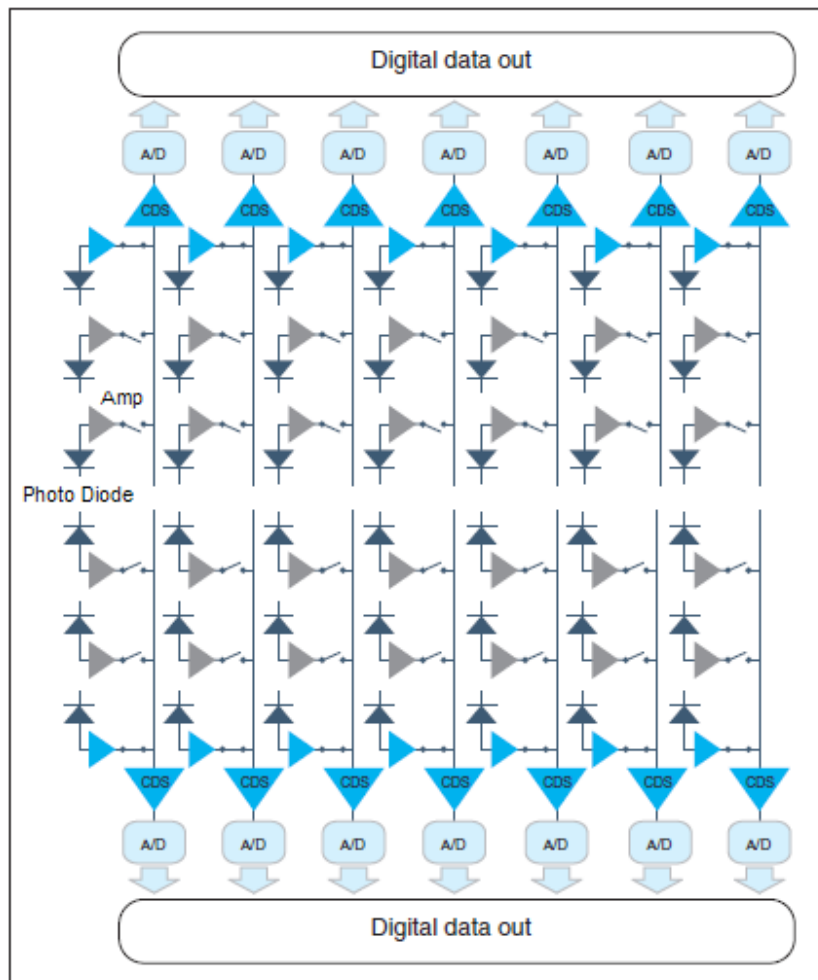

Figure 9-1 Structure of the CMOS image sensor

The exposure and the readout method of the CMOS image sensor is rolling shutter. In the rolling shutter, the exposure and readout are done line by line. Therefore, the exposure timing is different on one screen. (Figure 9-2)
But even if the object moves during the exposure, the affect of rolling shutter is very small.

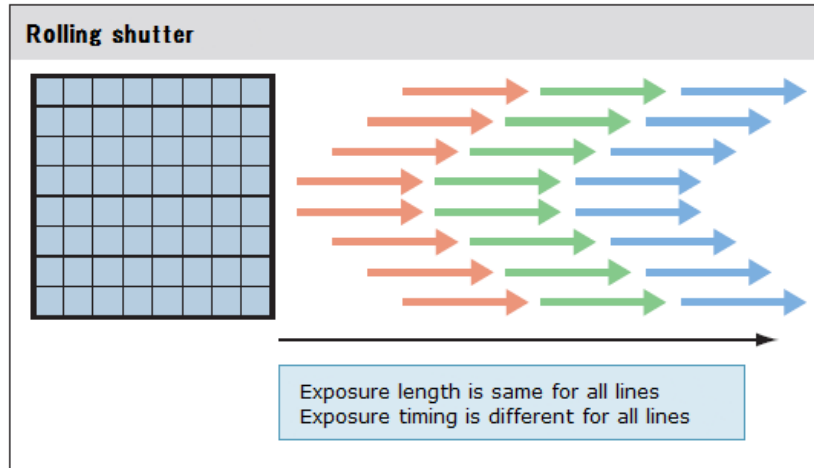

Figure 9-2 Exposure timing of Rolling shutter

9-2 NORMAL AREA MODE

9-2-1 Readout method (Scan mode)

With normal area mode, the camera reads out the CMOS image sensor from the center line to the top and from the center line to the bottom simultaneously (center line is depicted in red line in the diagram).

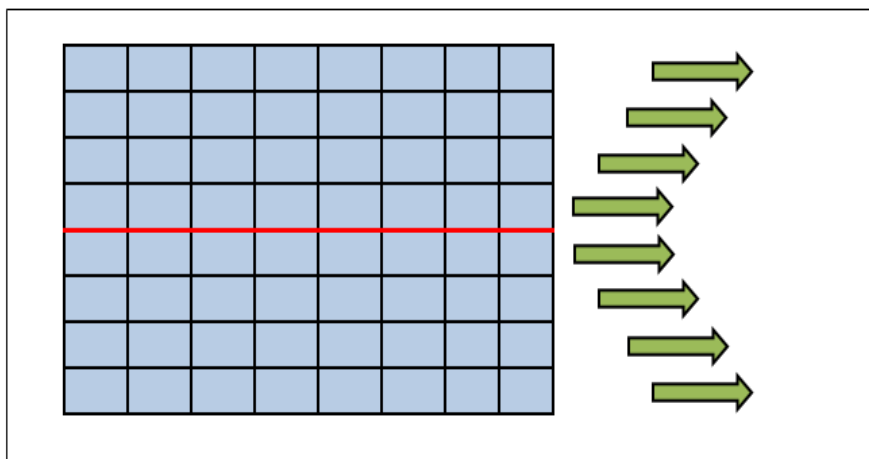

Figure 9-3 Readout method of normal area mode

The camera has the following scan modes.

(1) Normal readout

Perform charge readout from camera individually for all pixels.

(2) Binning readout

With this camera, 2×2 binning readout and 4×4 binning are available by adding the signal of adjacent pixels in the digital domain, Binning readout is a method for achieving high sensitivity in exchange for losing resolution.

(3) Sub-array readout

Sub-array readout is a procedure only a region of interest is scanned. It is possible to increase the frame rate by reducing the number of vertical lines scanned. When a target area is placed in the center of the screen, sub-array readout can perform the fastest readout. In sub-array readout, binning configuration is enabled.

Size and a position of the readout area can be configured according to the table below.

Binning	Settings			
	Horizontal		Vertical	
	Size	Position	Size	Position
1×1 (Normal readout)	512 pixels	32 pixels	8 lines	4 lines
2×2 binning readout	256 pixels	16 pixels	4 lines	2 lines
4×4 binning readout	128 pixels	8 pixels	2 lines	1 lines

9-2-2 Readout method (Scan speed)

The standard scan readout speed can achieve a frame rate of 30 fps for full resolution with low noise (0.9 electrons (median), 1.5 electrons (rms)), and the rapid rolling can achieve a frame rate of 40 fps for full resolution with low noise (1.3 electrons (median), 1.9 electrons (rms)).

Scan speed	Frame rate for full resolution	Readout noise
Standard scan	30 fps	0.9 electrons (median) 1.5 electrons (rms)
Rapid rolling	40 fps	1.3 electrons (median) 1.9 electrons (rms)

Note

- Please refer to 9-2-4 [FRAME RATE CALCULATION] about the frame rate of each readout mode. However, Rapid rolling is different from other modes.

9-2-3 Camera operation modes

The camera has the following operation modes.

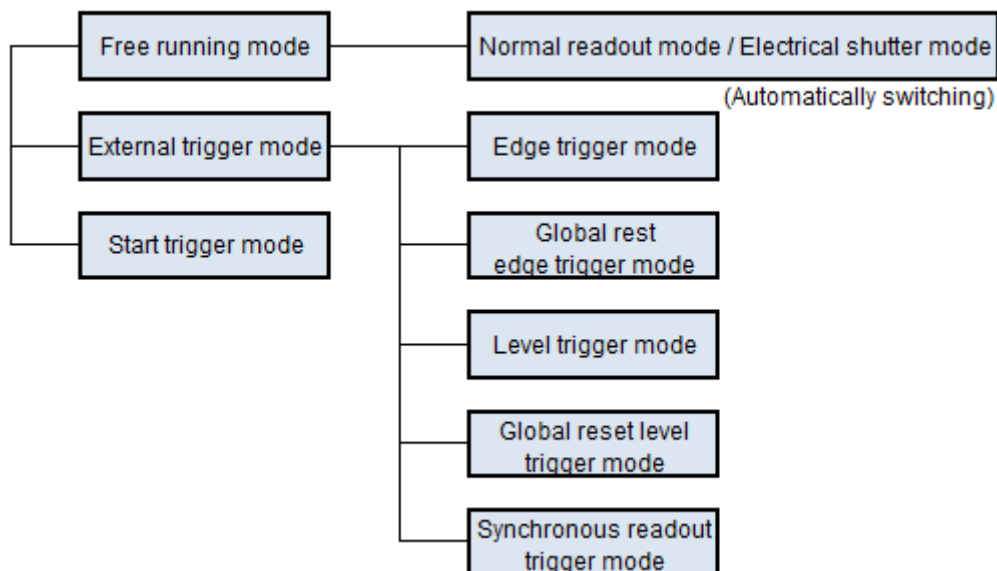

(1) Free running mode

The camera has the free running mode which the exposure and readout timing can be set by software command and controlled by an internal microprocessor. The free running mode has normal readout mode (in which the exposure time is longer than the 1 frame readout time) and electrical shutter mode (in which the exposure time is shorter than the 1 frame readout time). These readout modes are automatically switched depending on the exposure time setting.

(2) External trigger mode

The camera has various external trigger functions to synchronize the camera with the external equipment. In the external trigger mode, the external equipment becomes a master and the camera becomes a slave.

① Edge trigger mode / Global reset edge trigger mode

The edge trigger mode is used so that the exposure starts according to an external signal.

② Level trigger mode / Global reset level trigger mode

The level trigger mode is used to control both exposure start timing and exposure time length by inputting external trigger pulses.

③ Synchronous readout trigger mode

The synchronous readout trigger mode is used for continuous imaging when it is necessary to control the exposure start timing of each frame from an external source. It is useful for confocal microscopy.

(3) Start trigger mode

The start trigger mode is to start operating the camera by a trigger input for a continuous imaging.

Note

- Please refer to 9-2-6 [TIMING CHART OF CAMERA OPERATION MODES] about the detail of timing chart of these modes.

9-2-4 Frame rate calculation

(1) Standard scan

V_n = Number of vertical line (at the center area of the image sensor)

$Exp1$ = 3.021 ms to 10 s (input in units of seconds)

$1H$ = 32.4812×10^{-6}

Operation modes	Calculation formula	Horizontal	Vertical	Frame rate (fps)
Free running mode	$1/(V_n/2 \times 1H)$	2048	2048	30
			1024	60
			512	120
			256	240
			128	481
			64	962
			8	7696
External trigger mode (Edge trigger / Level trigger)	$1/(V_n/2 \times 1H + Exp1 + 10 \times 1H)$	2048	2048	27
			1024	50
			512	85
			256	133
			128	185
			64	228
			8	287
External trigger mode (Synchronous readout trigger)	$1/(V_n/2 \times 1H + 18 \times 1H)$	2048	2048	29
			1024	58
			512	112
			256	210
			128	375
			64	615
			8	1399

Note

- The calculation formula and the frame rate value of Start trigger mode (External trigger mode) are same as Free running mode. About this mode, refer to 9-2-6-2-4 "Start trigger mode".

(2) Rapid rolling

- H_n = Number of horizontal pixel
 V_n = Number of vertical line (at the center area of the image sensor)
 $Exp1$ = 1 ms to 10 s (input in units of seconds)
 $Exp2$ = 1.05 ms to 10 s (input in units of seconds)
 $1H$ = 10 μ s
 $round()$ = Round down to integer

Operation modes	Binning	Horizontal	Vertical	Calculation formula	$H_n \times V_n$	Frame rate (fps)	
Free running mode	1×1	$H_n > 512$	$8 \leq V_n \leq 2048$	$1/(round(V_n/2048/40/1H) \times 1H)$	2048×2048	40	
						2048×512	160
						2048×64	1282
		$H_n \leq 512$	$8 \leq V_n \leq 2048$	$1/(V_n/2 \times 1H)$	2048×8	11 111	
	512×2048				97		
	512×512				390		
	2×2	$64 \leq H_n \leq 1024$	$4 \leq V_n \leq 1024$	$1/(V_n \times 1H)$	1024×1024	97	
	4×4	$32 \leq H_n \leq 512$	$2 \leq V_n \leq 512$	$1/(V_n \times 2 \times 1H)$	512×512	97	
External trigger mode (Edge trigger)	1×1	$H_n > 512$	$160 \leq V_n \leq 2048$	$1/(round(V_n/2048/40/1H) \times 1H)$	2048×2048	40	
						2048×512	160
						$1/(V_n/2 \times 1H + Exp1 + 10 \times 1H)$	2048×64
		$H_n \leq 512$	$8 \leq V_n \leq 2048$	$1/(V_n/2 \times 1H + Exp1 + 10 \times 1H)$	2048×8	877	
	512×2048				88		
	512×512				273		
	2×2	$64 \leq H_n \leq 1024$	$4 \leq V_n \leq 1024$	$1/(V_n \times 1H + Exp1 + 10 \times 1H)$	1024×1024	88	
	4×4	$32 \leq H_n \leq 512$	$2 \leq V_n \leq 512$	$1/(V_n \times 2 \times 1H + Exp1 + 10 \times 1H)$	512×512	88	
External trigger mode (Level trigger)	1×1	$H_n > 512$	$160 \leq V_n \leq 2048$	$1/(round(V_n/2048/40/1H) \times 1H)$	2048×2048	40	
						2048×512	160
						$1/(V_n/2 \times 1H + Exp2 + 10 \times 1H)$	2048×64
		$H_n \leq 512$	$8 \leq V_n \leq 2048$	$1/(V_n/2 \times 1H + Exp2 + 10 \times 1H)$	2048×8	840	
	512×2048				87		
	512×512				269		
	2×2	$64 \leq H_n \leq 1024$	$4 \leq V_n \leq 1024$	$1/(V_n \times 1H + Exp2 + 10 \times 1H)$	1024×1024	87	
	4×4	$32 \leq H_n \leq 512$	$2 \leq V_n \leq 512$	$1/(V_n \times 2 \times 1H + Exp2 + 10 \times 1H)$	512×512	87	
External trigger mode (Synchronous readout trigger)	1×1	$H_n > 512$	$32 \leq V_n \leq 2048$	$1/(round(V_n/2048/40/1H) \times 1H)$	2048×2048	40	
						2048×512	160
						$1/(V_n/2 \times 1H + 18 \times 1H)$	2048×64
		$H_n \leq 512$	$8 \leq V_n \leq 2048$	$1/(V_n/2 \times 1H + 18 \times 1H)$	2048×8	543	
	512×2048				83		
	512×512				229		
	2×2	$64 \leq H_n \leq 1024$	$4 \leq V_n \leq 1024$	$1/(V_n \times 1H + 18 \times 1H)$	1024×1024	83	
	4×4	$32 \leq H_n \leq 512$	$2 \leq V_n \leq 512$	$1/(V_n \times 2 \times 1H + 18 \times 1H)$	512×512	83	

Note

- The calculation formula and the frame rate value of Start trigger mode (External trigger mode) are same as Free running mode. About this mode, refer to 9-2-6-2-4 "Start trigger mode".

9-2-5 Configuring exposure time

The exposure time setting can be done by absolute value. The actual exposure time setting is defined by the following formula, and the camera automatically calculates a larger and closest value from the specified exposure time setting.

(1) Standard scan

Exp1 = 3 ms to 10 s (129.99 μ s to 10 s with sub-array setting) (input in units of seconds)
Exp2 = Exp1 \div 32.4812 μ s (round up at decimal point)

Calculation formula	$32.4812 \mu\text{s} \times \text{Exp2}$
---------------------	--

(2) Rapid rolling

Exp1 = 1 ms to 10 s (40 μ s to 10 s with sub-array setting) (input in units of seconds)
Exp2 = Exp1 \div 10 μ s (round up at decimal point)

Calculation formula	$10 \mu\text{s} \times \text{Exp2}$
---------------------	-------------------------------------

Available setting range of the exposure time is the following.

Free running mode	3 ms to 10 s (Standard scan)
	1 ms to 10 s (Rapid rolling)
Free running mode (at Sub-array)	129.99 μ s* to 10 s (Standard scan)
	40 μ s* to 10 s (Rapid rolling)
External trigger mode	3 ms to 10 s (Standard scan)
	1 ms to 10 s (Rapid rolling)

Note

* 129.99 μ s (Standard scan) and 40 μ s (Rapid rolling) is the minimum exposure time when sub-array is set to 8 lines vertically symmetric (4 lines in top half and 4 lines in bottom half) with respect to the horizontally center axis. The minimum exposure time varies depending on vertical line number of sub-array setting.

9-2-6 Timing chart of camera operation modes

9-2-6-1 Free running mode

The camera has the free running mode which the exposure and readout timing can be set by software command and controlled by an internal microprocessor. The free running mode has normal readout mode (in which the exposure time is longer than the 1 frame readout time) and electrical shutter mode (in which the exposure time is shorter than the 1 frame readout time). These readout modes are automatically switched depending on the exposure time setting.

Note

- Please contact to Hamamatsu subsidiary or local distributor for the detail of the timing information.

9-2-6-1-1 Normal readout mode

The normal readout mode is suitable for observation, monitoring, field of view and focus adjustment, and animation because it can operate with full resolution, which is faster than the video rate (Standard scan : 30 fps, Rapid rolling : 40 fps).

In addition, the exposure time can be extended to collect more signals and increase the signal-to-noise ratio if the object is dark. In the normal readout mode, the exposure time is the same or longer than the 1 frame readout time. In this mode, the frame rate depends on the exposure time, and it becomes frame rate = 1/exposure time. The maximum exposure time is 10 s.

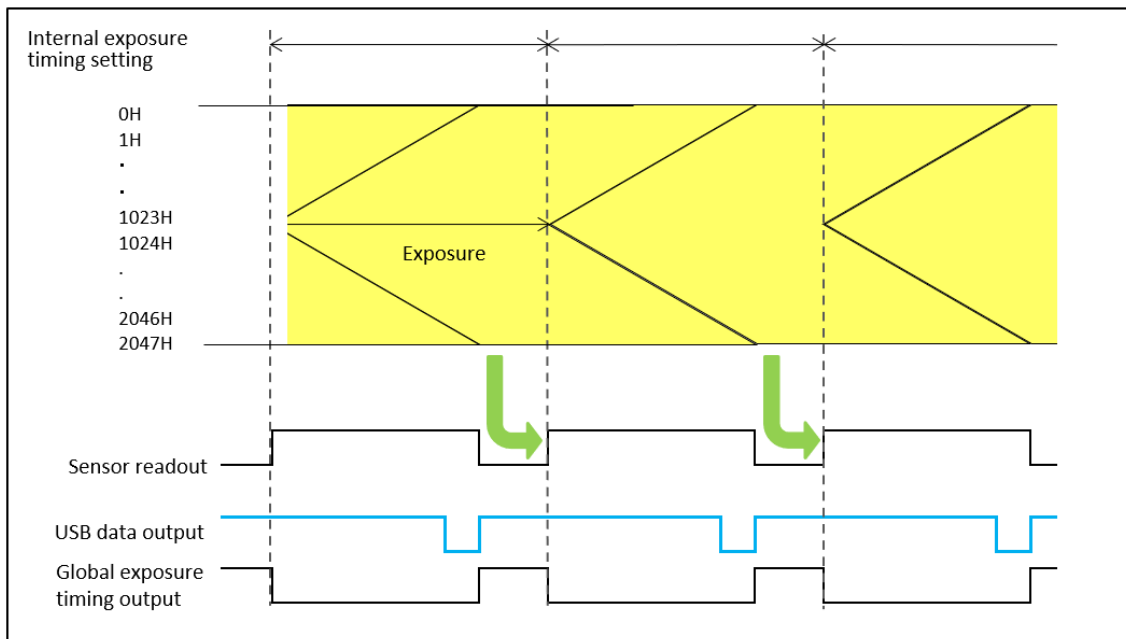

Figure 9-4

9-2-6-1-2 Electrical shutter mode

The electrical shutter mode is used to get a proper signal level when signal overflow happens due to too much input photons in normal readout mode. In this mode, the fastest frame rate is 30 fps in Standard scan and 40 fps in Rapid rolling at full resolution even when the exposure time is short.

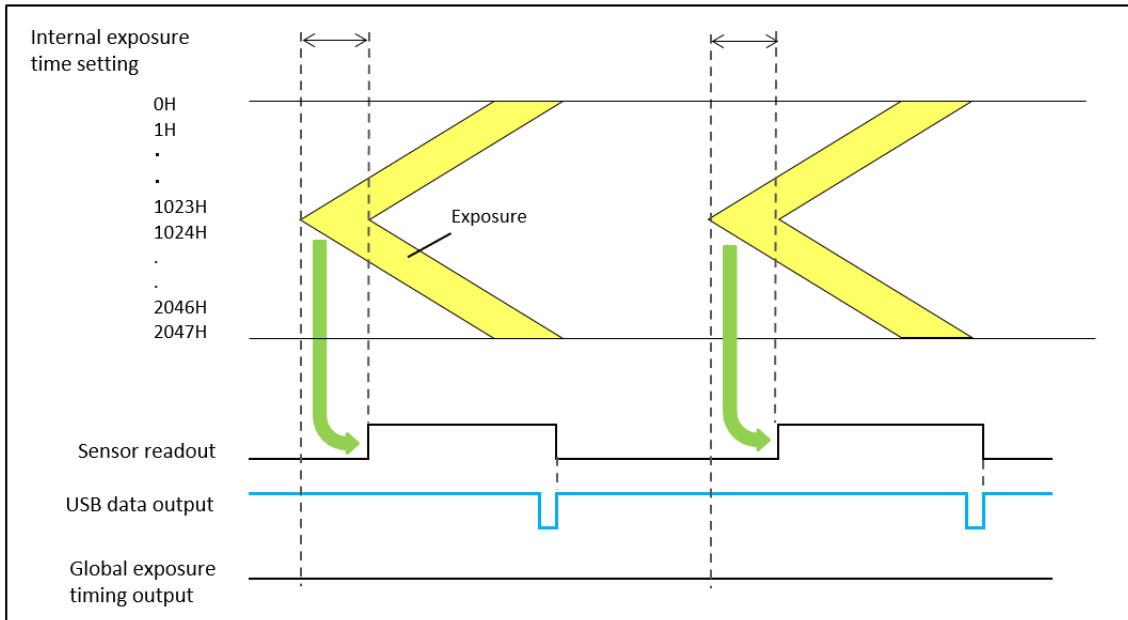

Figure 9-5

9-2-6-2 External trigger mode

The camera has various external trigger functions to synchronize the camera with the external equipment. In the external trigger mode, the external equipment becomes a master and the camera becomes a slave.

Note • Please contact to Hamamatsu subsidiary or local distributor for the detail of the timing information.

9-2-6-2-1 Edge trigger mode

The edge trigger mode is used so that the exposure starts according to an external signal. Exposure time is set by software command. In this mode, the exposure of the first line begins on the edge (rising/falling) timing of the input trigger signal into the camera. (1023H and 1024H in the following figure) The exposure of the second line is begun after the readout time of one line passes (1022H and 1025H in the following figure), and the exposure is begun one by one for each line.

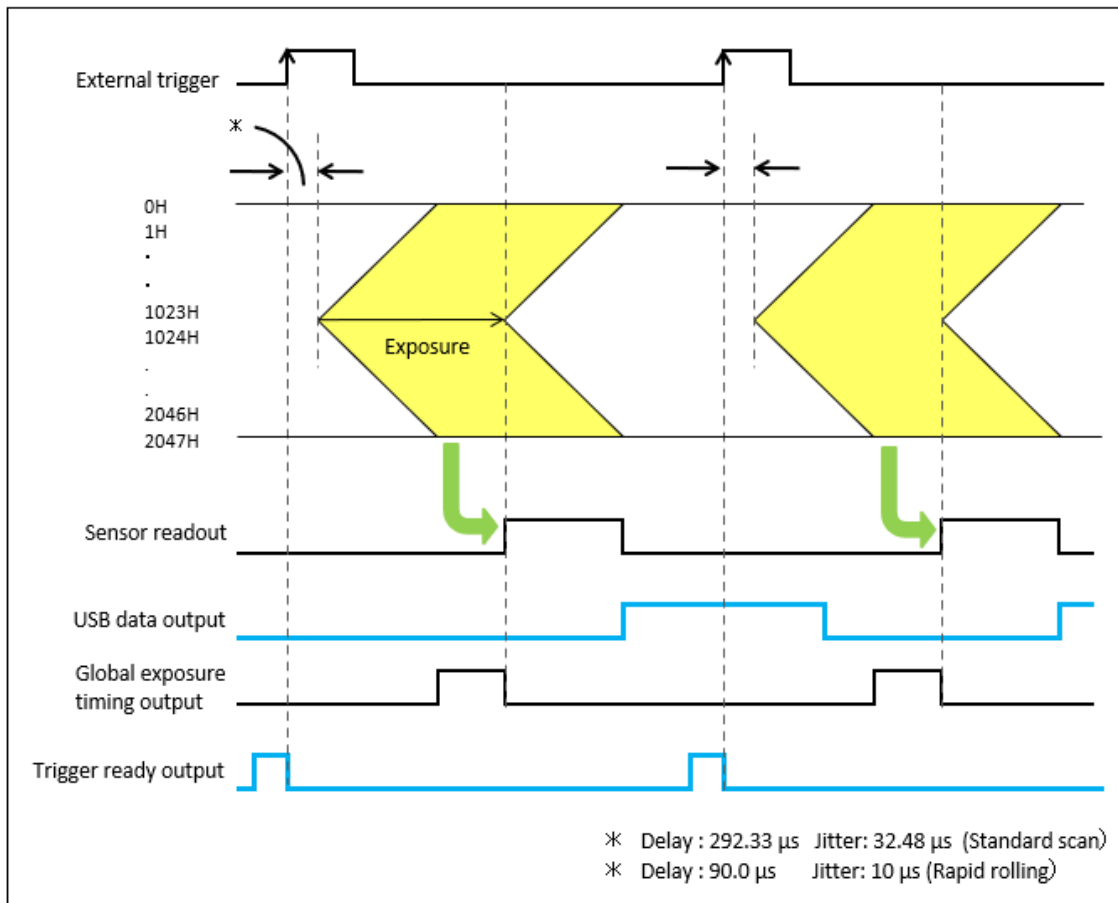

Figure 9-6 (Ex. rising edge)

9-2-6-2-2 Level trigger mode

The level trigger mode is used to control both exposure start timing and exposure time length by inputting external trigger pulses. In this mode, the camera starts exposure at the start of high or low period of the input trigger pulse and stops exposure at the end of high or low period of the input trigger pulse. The example below is for the trigger level High. The exposure of the first line begins when the trigger signal becomes High, and the exposure of the second line begins after the readout time of line one passes. Each exposure begins one by one for each line. The exposure of the first line is finished when the trigger signal becomes low, and signal readout is begun. The exposure time of each line is defined by the time that the input trigger is high. The minimum trigger pulse width is 3.18 ms (standard scan) or 1.05 ms (rapid rolling).

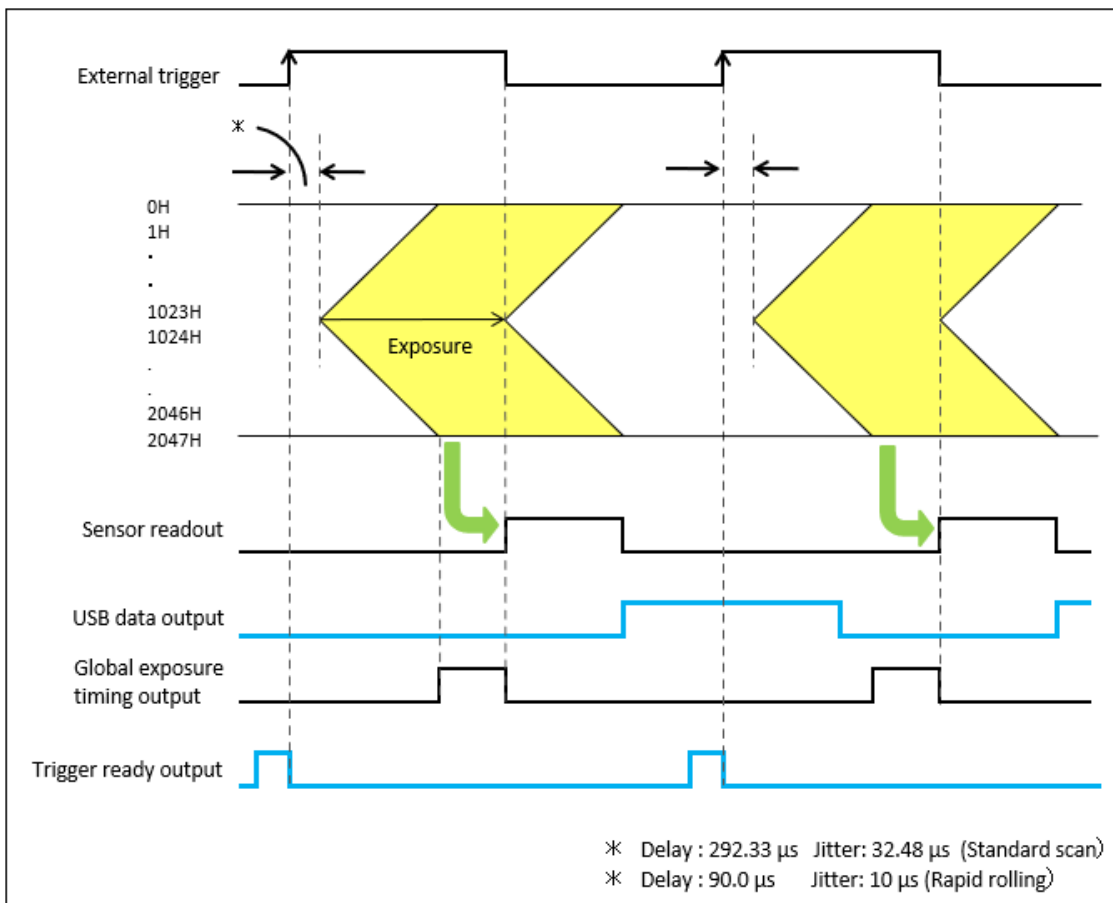

Figure 9-7 (Ex. rising edge)

9-2-6-2-3 Synchronous readout trigger mode

The synchronous readout trigger mode is used for continuous imaging when it is necessary to control the exposure start timing of each frame from an external source. It is useful for confocal microscopy. For example, when the camera is used with a spinning disk confocal microscope and the camera exposure time is synchronized to the spinning disk's rotation speed, it is possible to eliminate uneven illumination (called banding noise) caused by variation of the spinning disk rotation speed. Also, it is useful for securing as long exposure time as possible while controlling the exposure start timings by external trigger signals.

(1) Normal operation (when the trigger times is set as 1.)

The synchronous readout trigger mode is used for continuous imaging when it is necessary to control the exposure start timing of each frame from an outside source and also when it is necessary to secure as long exposure time as possible. In the synchronous readout trigger mode, the camera ends each exposure, starts the readout and also, at the same time, starts the next exposure at the edge of the input trigger signal (rising / falling edge). That is, the interval between the same edges of the input trigger becomes the exposure time.

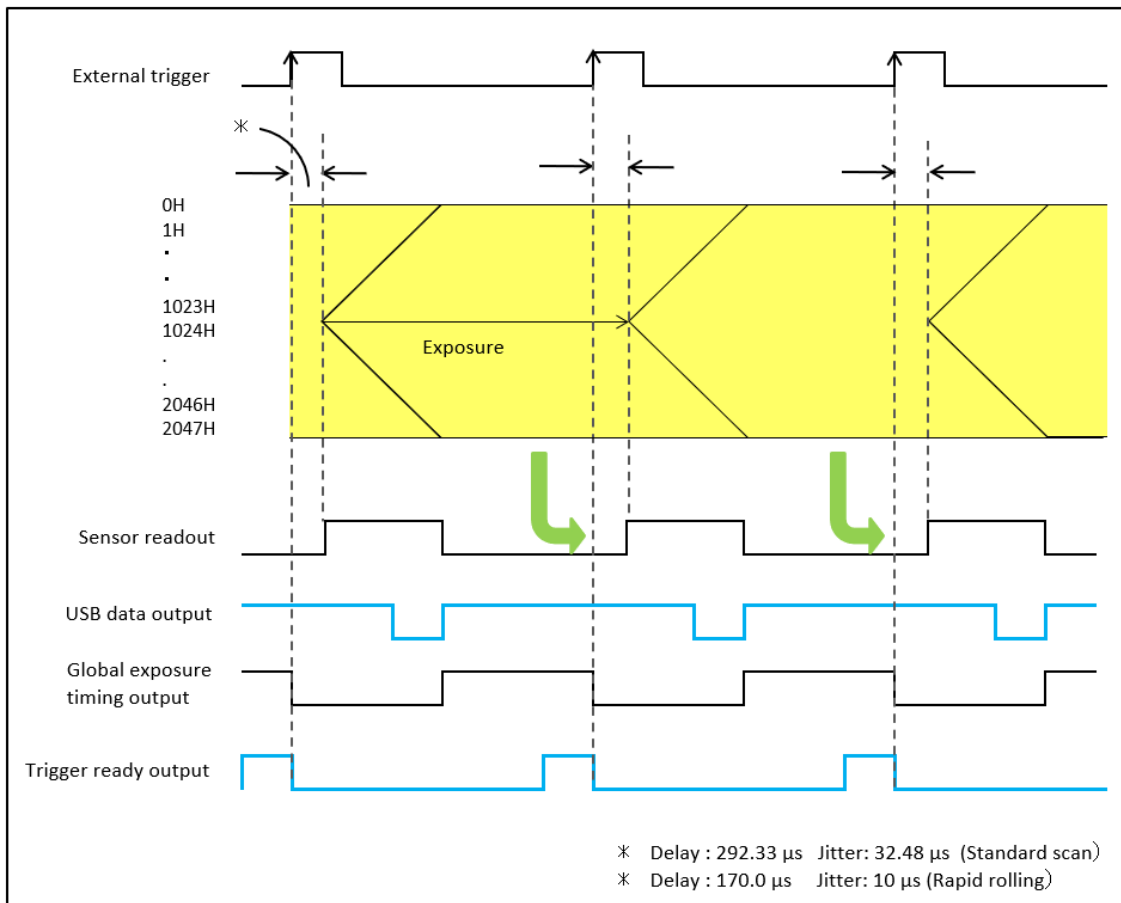

Figure 9-8 (Ex. rising edge)

(2) Trigger times

Also in the synchronous readout trigger mode, synchronous readout can be controlled by specifying, set by command, the number of timing pulses to determine the exposure time. The following figure shows the exposure timing when the Trigger Times is set as 3.

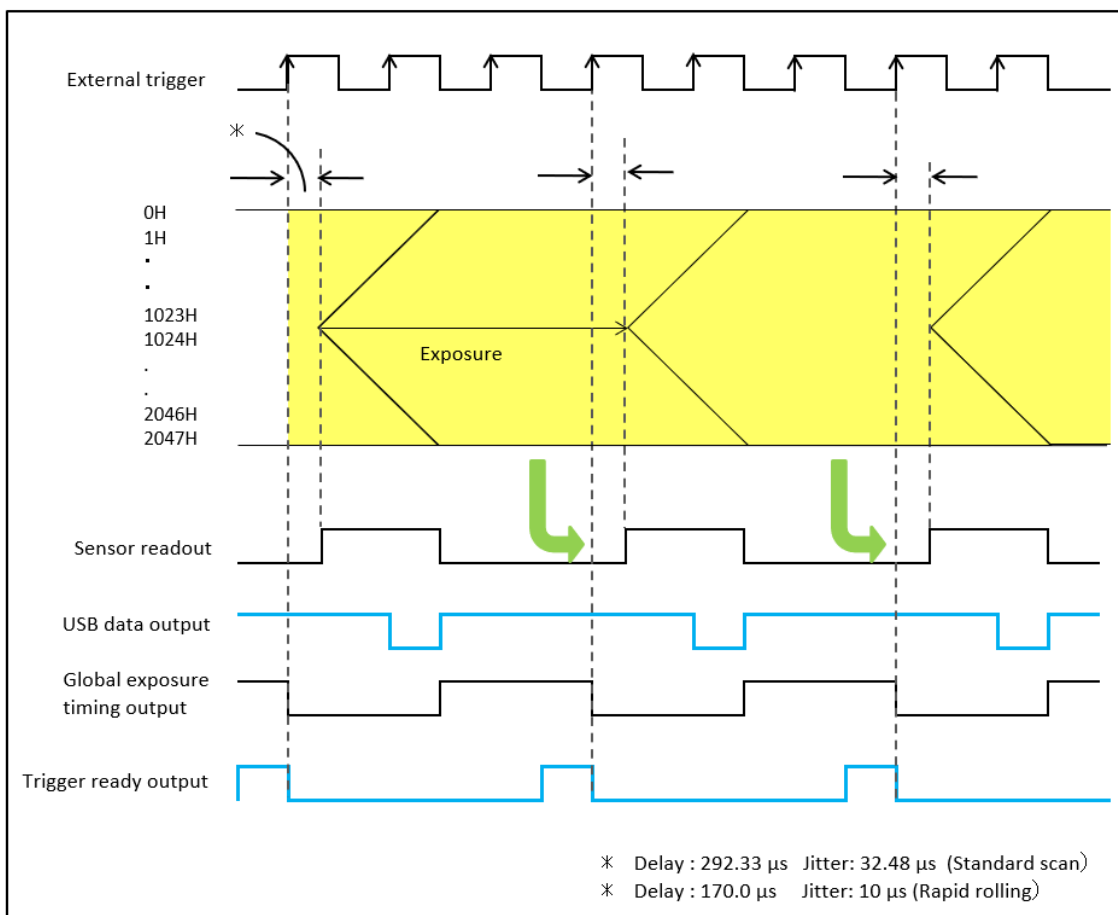

Figure 9-9 (Trigger Times)

9-2-6-2-4 Start trigger mode

The start trigger mode is to start operating the camera by a trigger input for a continuous imaging. It is useful to secure the frame rate as fast as possible when continuous image acquisition and not to sacrifice the exposure time. For example, when it is necessary to measure the phenomenon after stimulation, it is possible to start continuous image acquisition at the stimulation timing.

The start trigger mode is to start operating the camera by a trigger input for continuous imaging, and it works at the highest frame rate because it is operated in free running mode. In the start trigger mode, the camera starts exposure and switches to free running mode by the edge of an external trigger signal (rising / falling edge).

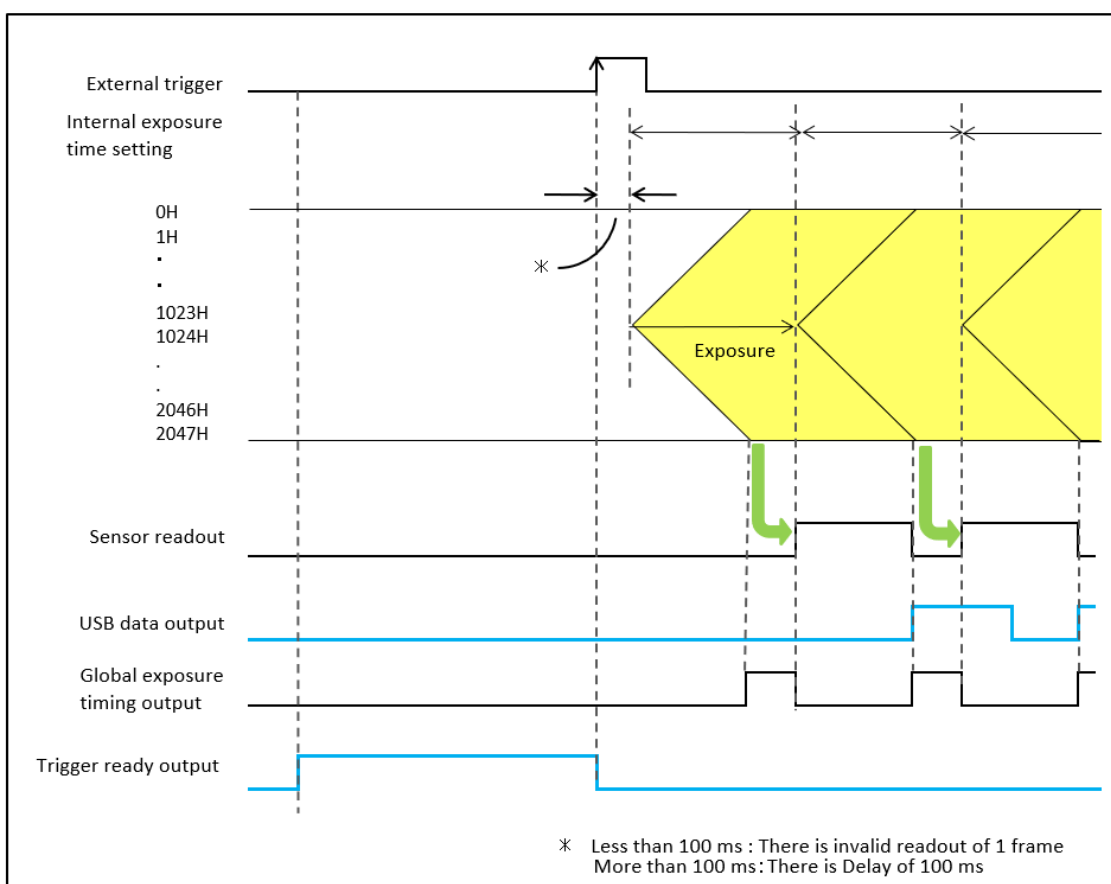

Figure 9-10 (Ex. rising edge)

9-2-6-2-5 External trigger delay function

In most cases when a delay between the laser pulse emission and the exposure start is needed, a delay unit is set between the laser and camera to control trigger timing. In each external trigger mode of the camera, the delay can be set to the trigger signal input to the camera by command. With this setting, a range of trigger can be arranged without a delay unit. The range for delay time is 0 μ s to 10 s (1 μ s steps).

9-2-6-3 Trigger output

The camera provides a range of trigger output signals to synchronize with an external instrument and the camera becomes the master and the external instrument becomes the slave. There are three different trigger output functions as follows. Also, it can output continuous High output (High output fixed) or continuous Low output (Low output fixed).

These three different trigger output functions can be selected by software command, and they are output from Timing out connector.

Note

- Please refer to Figure 9-4 to Figure 9-10 about details of each trigger output functions.

9-2-6-3-1 Global exposure timing output

It shows the global exposure timing where all lines expose at the same time. There is a case that one event is divided into two frames because the timing of the exposure in each line is different for the rolling shutter. However, by using the Global exposure timing output the global exposure becomes possible for the phenomenon that happens for this period. Global exposure timing output shows the period where all lines expose at the same time.

Note

- There is no output signal when the exposure time is less than the frame rate.

9-2-6-3-2 Programmable timing output

By using the programmable timing output, synchronizing external devices is simple. A system that needs simple timing signal does not require a delay unit or pulse generator. It is possible to program and output a pulse that has an optional pulse width and an optional delay time to the end of readout timing or Vsync. The setting range for delay time is 0 μ s to 10 s, and the setting range for pulse width is 1 μ s to 10 s.

The relation between the parameter which can be set with each reference signal, and an output signal becomes below.

Reference signal	Output signal
Read End	Camera outputs a pulse after certain delay, from the end of sensor readout. Also the pulse width can be set.
Vsync	Camera outputs a pulse after certain delay, from the beginning of readout. Also the pulse width can be set.

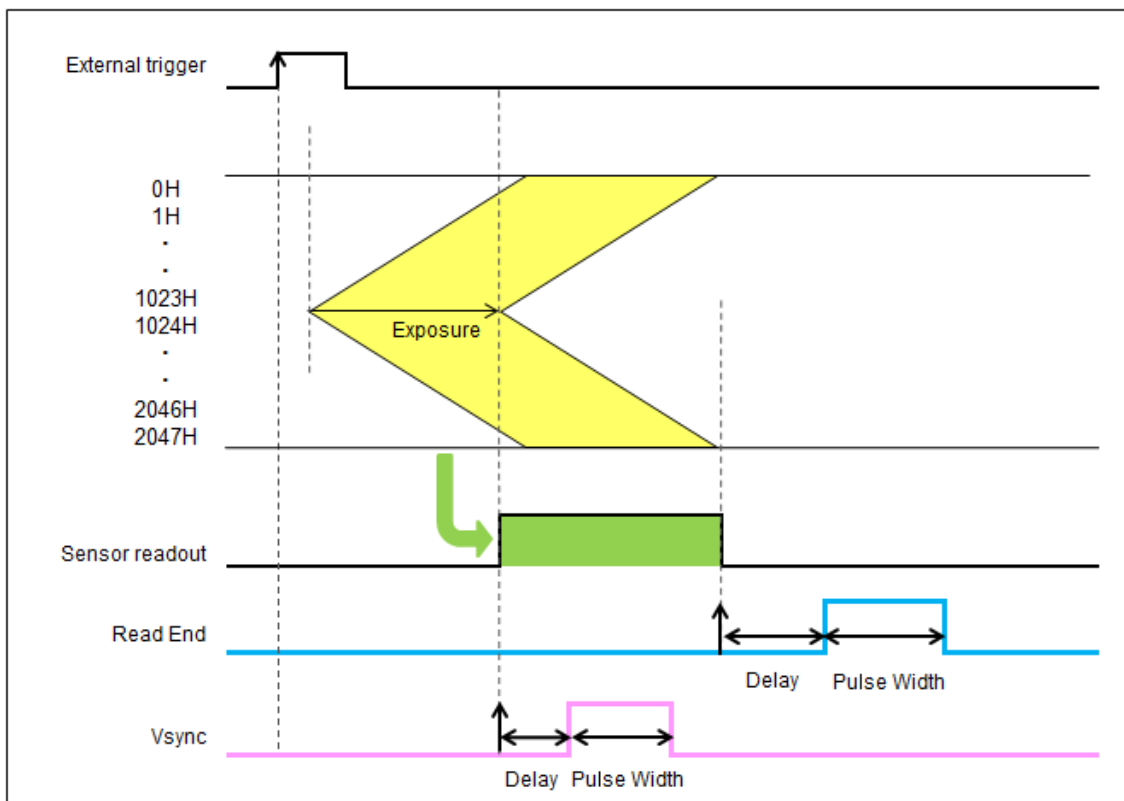

Figure 9-11

9-2-6-3-3 Trigger ready output

The trigger ready output is useful to make the frame intervals as short as possible in external trigger mode. For example, when the camera is working in the edge trigger mode, the next frame can start after the previous frame exposure is done. Thus, the camera cannot accept a trigger for the next frame during the exposure period. To reduce useless time to be as short as possible, it is necessary to know the period when the camera can accept a trigger for the next frame. The trigger ready output shows the trigger ready period when the camera can accept an external trigger in the external trigger mode.

9-2-6-4 Global reset

Global reset function enables to reset the electric charge of all pixels at the same time. Then all pixels can start exposure at the same time.
Global reset can work with Edge trigger mode and Level trigger mode.

9-2-6-4-1 Edge trigger mode

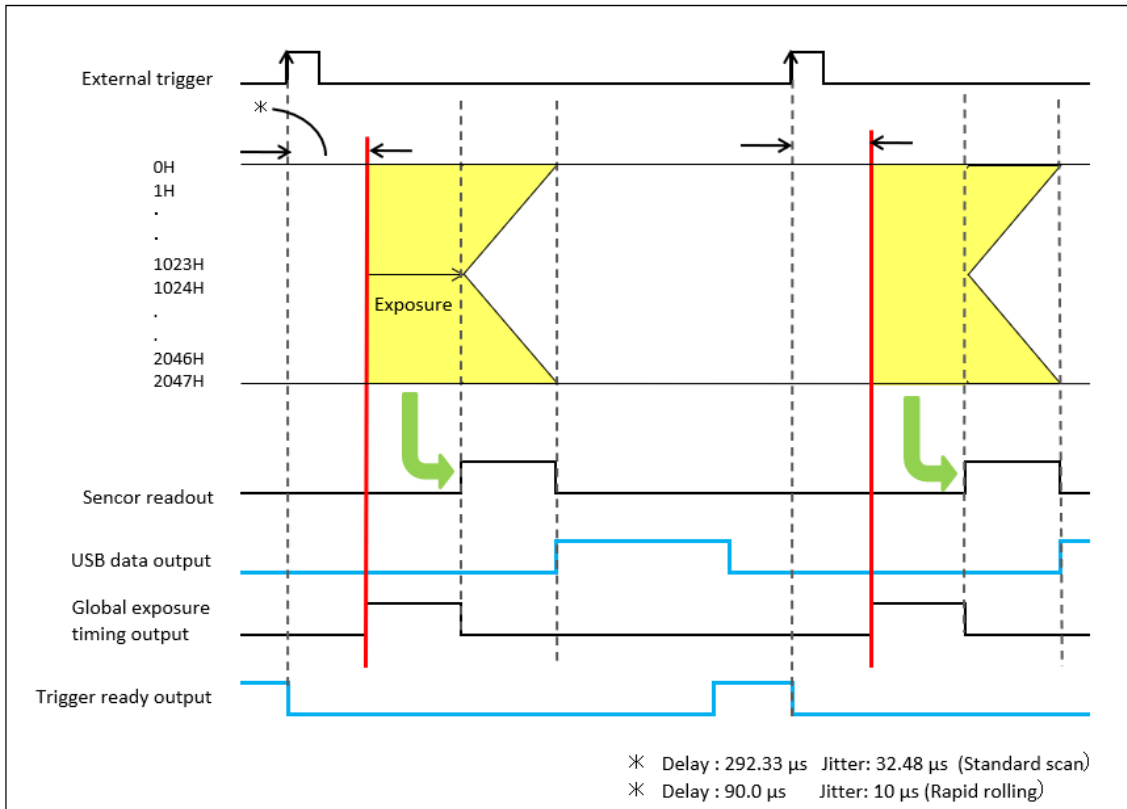

Figure 9-12

9-2-6-4-2 Level trigger mode

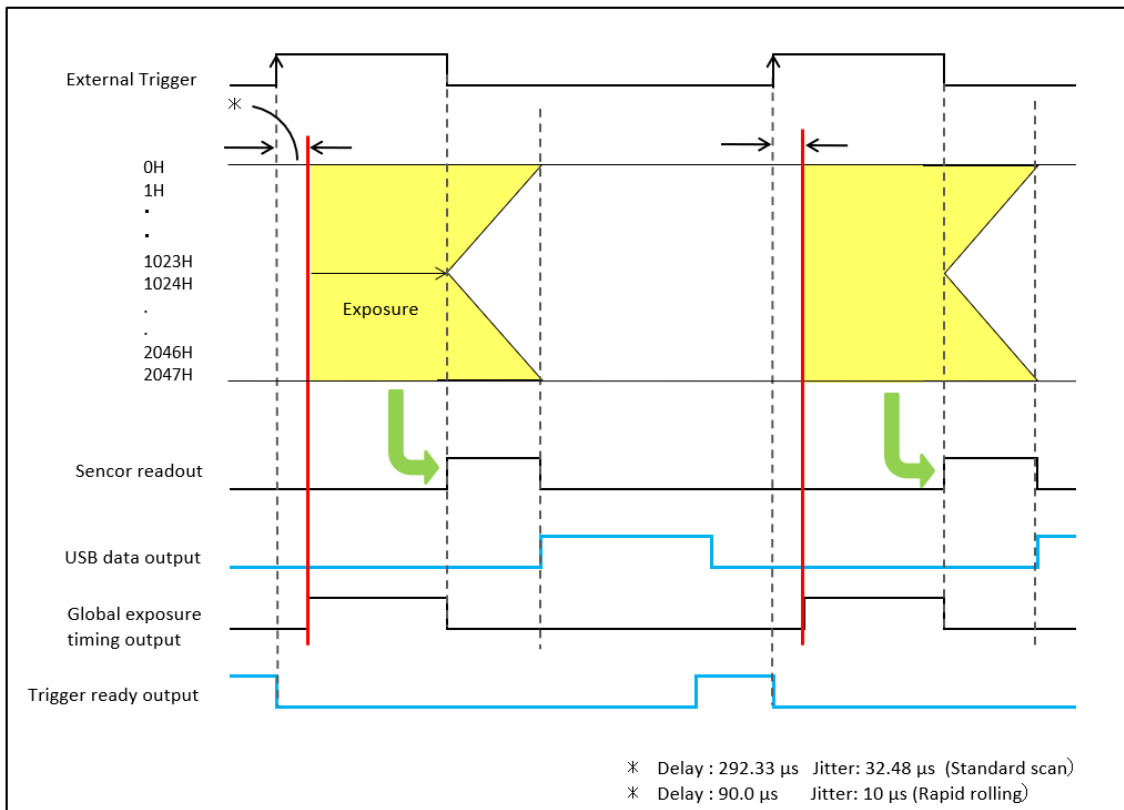

Figure 9-13

9-3 REAL-TIME CORRECTION FUNCTIONS

There are a few pixels in the CMOS image sensor that have slightly higher readout noise performance compared to surrounding pixels. The camera has real-time variant pixel correction features to improve image quality. The correction is performed in real-time without sacrificing the readout speed at all. This function can be turned ON and OFF. (Default is ON)

10. PRECAUTION WHEN USING THE CMOS IMAGE SENSOR

This camera uses the scientific CMOS image sensor. Careful attention must be paid to the following points when using the CMOS image sensor:

(1) White spot

CMOS image sensor has some high dark current pixels caused by the defect of silicon wafer. Those high dark current pixels appear as higher intensity and brighter pixels than around pixels when the exposure time is set long. Those pixels are called as “White spot” (“hot pixel”).

This camera has real time defect pixel correction function which can replace the defect pixels registered in advance with the data of surrounding pixels.

Hitting of cosmic ray or radiation ray (X-ray, gamma ray, UV light, etc.) on the sensor generates many electrons and they may appear as a white spot, but this white spot is temporary and disappear in the next frame.

In addition, although the probability is very low, the impact of cosmic rays and radiation (X-rays, gamma rays, ultraviolet rays, etc.) is large, and it may cause permanent defects in silicon wafers and defective pixels with large dark current. In current technology, there is no way to avoid generating high dark current defect pixels. It means there is a possibility to generate new white spots after the factory shipment.

Even if the white spot occurs, dark offset subtraction* with software can reduce the effect of white spots because intensities of white spots are proportional to the exposure time and have reproducibility with a constant sensor temperature.

* After acquiring an image using a certain exposure time is loaded, the CMOS image sensor is exposed to darkness for the same amount of time, and another image is obtained. After this, the difference between the images is determined, and the data for the dark portion of the original image is nullified.

(2) Folding distortion

A rough-edged flicker may be visible when imaging striped patterns, lines, and similar subject matter.

(3) Over light



- Be careful not to input too strong light such as high-energy laser into the CMOS image sensor because the CMOS image sensor may be damaged by over light.

11. MAINTENANCE

11-1 CARE

Perform cleaning of the camera with the dry soft cloth.



- Do not wipe with a damp cloth or unclean cloth.

Then, the glass window on the CMOS image sensor should be cleaned according to the following.

- (1) Blow the dust from the glass window with an air duster.
- (2) Moisten a lens cleaning paper with a little ethanol, and wipe over center area of the window, gently.



- Use Lens Cleaning Paper for cleaning of glass window in front of the CMOS image sensor.



- Use a plastic tweezers and take extra care not to scratch the glass window with the tweezers. Even with plastic tweezers, there is possibility to make scratch on the glass window in case tweezers touch it.



- Avoid touching the surrounding parts of image area when wiping the glass window.

- (3) Confirm whether dust is not left.

Attach the camera to an optics, and check if there is dust or not under the uniform light condition. If there is dust on the image, please clean the glass window again.

12. TROUBLESHOOTING

If an anomaly occurs, look up the possible causes in the following tables and, if necessary, report the details to a Hamamatsu subsidiary or your local distributor.

12-1 IMAGE IS NOT TRANSFERRED

Cause	Measures	Chapter
AC adapter or other cable is loose	Reconnect the cable	7
AC adapter or other cable is broken	Replace the cable	7
The correct command has not been sent to the camera	Recheck command	

12-2 ALTHOUGH IMAGES ARE TRANSFERRED

(1) Scratches or discoloration visible on the screen

Cause	Measures	Chapter
Lens is dirty	Wipe the lens	11

(2) Image is blurred

Cause	Measures	Chapter
Lens is not focused	Contact Hamamatsu subsidiary or local distributor	16
Condensation appear	Confirm the operating environmental conditions	13

(3) Only shadowed images are output

Cause	Measures	Chapter
Lens mount cap has been left on	Remove the cap	
Amount of light is too much or too low	Adjust amount of light	

(4) All screens overflow

Cause	Measures	Chapter
Too much amount of light	Reduce amount of light	
Contrast enhancement is too high	Reduce gain	

(5) Noise appears on the screen

Cause	Measures	Chapter
Exogenous noise	Find and remove cause	
Poor connection of internal connector	Contact Hamamatsu subsidiary or local distributor	16
Defective circuit system		

13. SPECIFICATIONS

13-1 CAMERA SPECIFICATIONS

(1) Electric specifications

Imaging device	Scientific CMOS image sensor	
Effective number of pixels	2048 (H) × 2048 (V)	
Cell size	6.5 μm (H) × 6.5 μm (V)	
Effective area	13.312 mm (H) × 13.312 mm (V)	
Full well capacity *1	30 000 electrons	
Cooling method	Peltier device + Forced air-cooled	
Cooling temperature	+ 10 °C (Ambient temperature: + 10 °C to + 30 °C, Fan Speed: Fast)	
Conversion factor *1	0.46 electrons/count	
Digital output	16 bit	
Dark offset	100 counts(at Normal readout) 400 counts(at 2x2 Binning readout) 1600 counts(at 4x4 Binning readout)	
Sensor readout time	33 ms (Standard scan) 10 ms (Rapid rolling)	
Readout speed (Frame rate)	at Full resolution	30 fps (Standard scan) 40 fps (Rapid rolling)
	at 1024 lines at center position	60 fps (Standard scan) 80 fps (Rapid rolling)
	at 8 lines at center position	7696 fps (Standard scan) 11 111 fps (Rapid rolling)
	at Horizontal 512 pixels at 8 lines at center position	7696 fps (Standard scan) 25 000 fps (Rapid rolling)
Readout mode	Normal readout mode	1×1
	Binning readout mode*2	2×2,4×4
	Sub-array readout mode	Configurable for each vertical 8 pixels and horizontal 512 pixels.
Readout noise *1	0.9 electrons median (Standard scan) 1.5 electrons rms (Standard scan)	
	1.3 electrons median (Rapid rolling) 1.9 electrons rms (Rapid rolling)	
Dark current *1	0.6 electron/pixel/s (at Cooling temperature: + 10 °C)	
Dynamic range	33 000 : 1*3 20 000 : 1*4	
Dark Signal Non-Uniformity (DSNU) *1	0.3 electrons	
Photo Response Non-Uniformity(PRNU) *1	15 000 electrons	0.2 %
	700 electrons	0.4 %
Linearity error*1	EMVA1288 standard	0.5 %
	< 500 electrons signal	0.3 %

Exposure time	Free running mode	3 ms to 10 s (Standard scan) 1 ms to 10 s (Rapid rolling)
	Free running mode / Sub-array mode	129.99 μ s to 10 s (Standard scan) 40 μ s to 10 s (Rapid rolling)
	External trigger mode	3 ms to 10 s (Standard scan)
		1 ms to 10 s (Rapid rolling)
External trigger mode	Edge trigger / Global reset edge trigger / Level trigger / Global reset level trigger / Synchronous readout trigger / Start trigger	
Software trigger input mode	Edge trigger / Global reset edge trigger / Start trigger	
External trigger input connector	SMA connector	
External trigger input level	TTL / 3.3 V LVCMOS	
External trigger input polarity	Positive / Negative	
External trigger input delay function	0 μ s to 10 s (1 μ s steps)	
Trigger times (at Synchronous readout trigger)	1 to 10 000 times (1 step)	
External trigger output	Global exposure timing output / Trigger ready output / Programmable timing output / High output / Low output	
External trigger output connector	SMA connector	
External trigger output level	3.3 V LVCMOS level	
External trigger output polarity	Positive / Negative	
Programmable timing output	Reference signal	Read End / Vsync
	Delay	0 μ s to 10 s (1 μ s steps)
	Pulse width	1 μ s to 10 s (1 μ s steps)
Image processing function	Real-time defect pixel correction (ON or OFF)	
Sensor temperature reading function [unit]	1 $^{\circ}$ C	
Interface	USB 3.1 Gen 1 ^{*5}	
Interface connector	USB MicroB type	
Lens mount	C-mount	

*1 Typical value

*2 Digital binning processing in the camera.

*3 Calculated from the ratio of the full well capacity and the readout noise median (Standard scan).

*4 Calculated from the ratio of the full well capacity and the readout noise r.m.s (Standard scan).

*5 Equivalent to USB 3.2 Gen 1 (SuperSpeed USB 5 Gbps)

(2) Power supply specifications

Camera	Input power supply	DC12 V
	Power consumption	45 W
AC adapter	Input power supply	AC100 V to AC240 V 50 Hz/60 Hz
	Typical output	DC12 V
	Power consumption	75 VA

Note

- Fluctuations of input power supply voltages are not to exceed $\pm 10\%$ of the nominal voltage.

(3) Operating environment

Ambient operating temperature	0 °C to + 40 °C (Fan Speed: Fast) 0 °C to + 35 °C (Fan Speed: Middle, Slow)
Ambient storage temperature	-10 °C to + 50 °C
Ambient operating humidity	30 % to 80 %, no condensation
Ambient storage humidity	Less than 90 %, no condensation
Place of operating	Indoor, altitude up to 2000 m

(4) Dimensional outline and weight

Dimensional outline	85 mm (W) × 85.5 mm (H) × 117.6 mm (D)	
Weight	Camera	Approx. 1.1 kg
	AC adapter + power supply cord	Approx. 1.0 kg

Note

- Please see 14. [DIMENSIONAL OUTLINES] for detail of dimensions.

(5) Applicable standards

EMC	EN61326-1: 2013 Class A Emission limits: CISPR 11 Group1 Class A Immunity requirements: Table2	
	Function performance and operation mode in immunity tests	Intensity fluctuation of image is within ± 5 %.
	Restoration procedure in immunity tests	Exit the image acquisition software, turn off the power of camera and focus adjustment unit. And then turn on the power of each device. Open the image acquisition software.
FCC	47 CFR FCC Part15 Subpart B Class A	

13-2 SPECTRAL RESPONSE CHARACTERISTICS(TYP.)

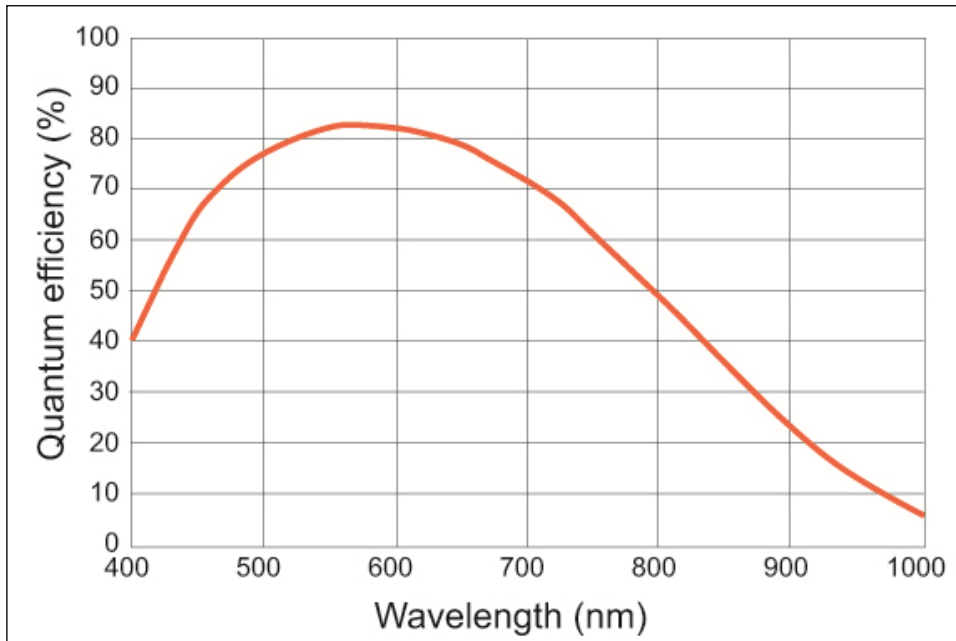
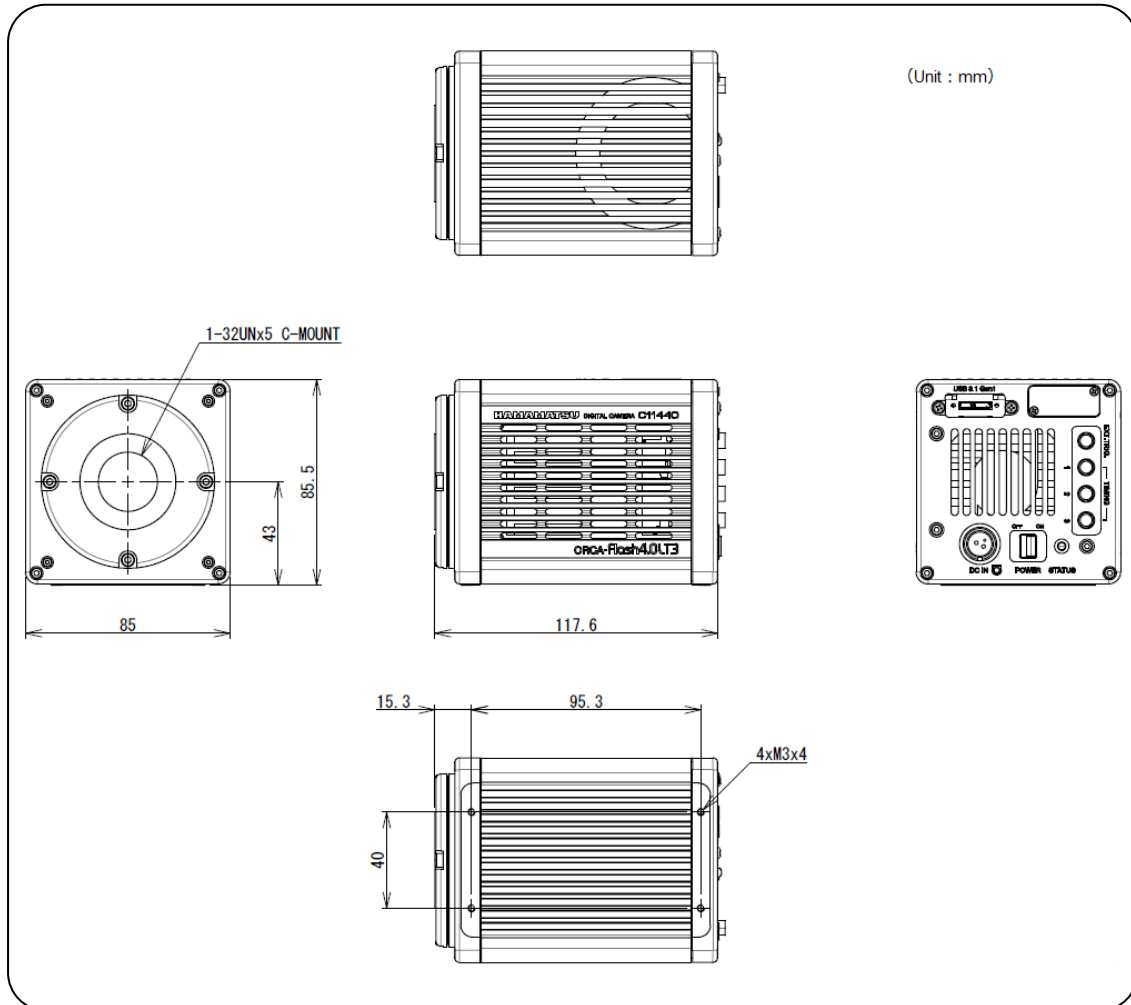

Figure 13-1

14. DIMENSIONAL OUTLINES

14-1 C11440-42U40



15. WARRANTY

Hamamatsu Photonics have fully inspected this camera and checked that its performance conforms to specifications. In the unlikely event of a breakdown or other malfunction, contact a Hamamatsu subsidiary or your local distributor.

15-1 BASIC WARRANTY

- (1) Unless otherwise stated by Hamamatsu subsidiary or local distributor, this camera is under warranty for 24 months from the delivery date.
 - Degradation with cosmic rays, the radiation (X-rays, gamma rays, UV light, etc.) of the CMOS image sensor is excepted.
- (2) The warranty only covers defects in the materials and manufacturing of the camera. You may be liable for repairs during the warranty period in the event of a natural disaster or if you handle the camera contrary to the instructions in this manual, use it without due caution, or try to modify it.
- (3) We will repair the camera or replace it, subject to availability, free of charge within the terms of the warranty.

15-2 REPAIRS

- (1) If you notice anything wrong with the camera, confirm whether or not it is malfunctioning by referring to the TROUBLESHOOTING in this instruction manual. You must first clarify the symptoms in order to avoid any misunderstanding or error.
- (2) If you have any trouble or are unclear about anything, contact a Hamamatsu subsidiary or your local distributor giving the product name, serial number and details of the problem. If Hamamatsu Photonics consider the problem to be a malfunction, we will decide whether dispatch an engineer or have the camera returned to us for repairs.

16. CONTACT INFORMATION

Manufacturer

HAMAMATSU PHOTONICS K. K., Systems Division

812 Joko-cho, Higashi-ku, Hamamatsu City, 431-3196, Japan

Telephone (81) 53-431-0124, Fax: (81) 53-435-1574

E-mail: export@sys.hpk.co.jp

Local contact information worldwide could be found under:

www.hamamatsu.com

- *The contents of this manual are subject to change without notice.*
- *The unauthorized reproduction or distribution of parts or all of this manual is prohibited.*
- *If one of the following problems occurs, please contact Hamamatsu Photonics.
(See the CONTACT INFORMATION.) We will deal with the problem immediately.*
 - *Some contents of the manual are dubious, incorrect or missing.*
 - *Some pages of the manual are missing or in the wrong order.*
 - *The manual is missing or dirty.*